INTEGRA LIGHTWEIGHT CONCRETE INTERTENANCY SYSTEM



TECHNICAL MANUAL

Version 2 - November 2019

INTEGRA LIGHTWEIGHT CONCRETE SYSTEMS

INTEGRA Lightweight Concrete Intertency System

Comfort & Safety are paramount features for owners when they are looking at working with Architects & Engineers on a project.

Our central barrier intertenancy wall system is designed for use in medium & high density housing developments which has passed rigorous independent acoustic & fire testing to exceed the requirements of the building code.

The INTEGRA Lightweight Concrete Intertency System is a proprietary high-performance wall system that provides you tested systems for resistance to horizontal fire and acoustic separation between adjacent tenancies in the same building.

Enjoy the benefits of our tested, trusted barrier intertenancy walling system for your next project.



Innovative design
+
Enduring performance
+
Integrated systems



NTEGRA
LIGHTWEIGHT CONCRETE SYSTEMS

SYSTEM FEATURES:

- + All weather construction.
- + Fast installation
- + Low waste
- + 290mm – 336mm max Overall wall widths
- + Proprietary acoustic dampening bracket
- + Cost effective – Limited components.
- + Non-specialist trade installation.
- + All systems FRR 120/120/120•
- + STC & Rw 67 with one system

Innovative design
Integrated systems
Enduring performance

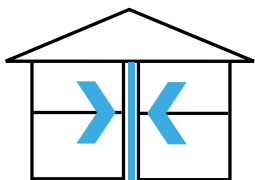

INTA120a



Page 16

INSA120a



Page 21

INTA120b

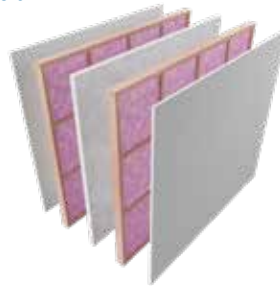

Page 17

INSA120b

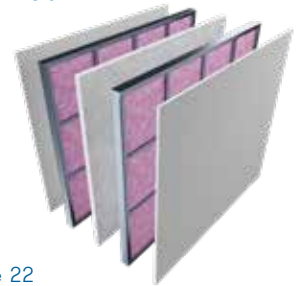

Page 22

INTA120c

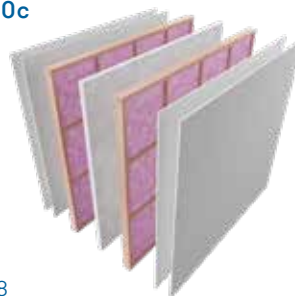

Page 18

INSA120c

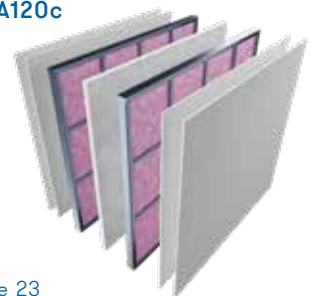

Page 23

INTA120d

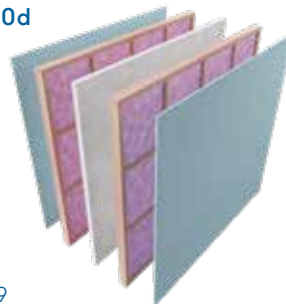

Page 19

INSA120d

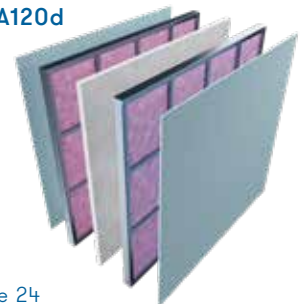

Page 24

INTA120e

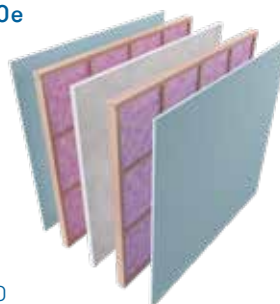

Page 20

INSA120e

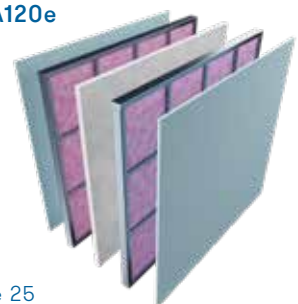

Page 25

Contents

Contents	4
System Specification Table	6
1. General System Description	7
2. Terminology	7
3. Specification Reference Labelling	8
4. Product Substitution	8
5. Components not supplied	8
6. Scope of use for the INTEGRA Lightweight Concrete Intertenancy System	8
7. Cavity Size	8
8. Compliance with the NZBC	9
B1 – Structure	9
B2 – Durability	9
C1-C6 – Protection from Fire	9
F2 – Hazardous Building Materials	10
G6 – Airborne and Impact Sound	10
9. Services	10
10. Exposure to weather during construction	11
11. Materials	11
Fasteners	11
Intertenancy Bracket	11
INTEGRA Panel Central Barrier	11
PSL AAC Adhesive	11
Anti-Corrosion Coating	11
Wall Insulation	11
12. System Variations	11
13. Installation Guidelines	12
General	12
Step 1- Framing	12

	Step 2 - Installation of brackets	12
	Step 3 - Mixing and Application of mortar, install the bottom row of Integra panel	13
	Step 4 - Installation of Integra Panel in the wall cavity	13
	Step 5 - Screw fixing the panels to the brackets	14
	Step 6 - Install the framing to the other side of the central barrier	14
	Step 7 - Installation of services	15
	Step 8 - Installation of insulation	15
	Step 9 - Installation and finishing of Plasterboard	15
	Step 10 - Finishing services	15
	System specification	16 - 25
15	Typical Uses	26
	Intertenancy Bracket	27
	Vertical Cross Section	28
	Wall Plan	29
	Wall Plan - Panel Join	30
	Wall Elevation	31
	Foundation or Intermediate Floor Slab	32
	Corner - Internal Linings both Sides	33
	Wall Projection - Plan View	34
	T-Junction - Internal Wall meeting Intertenancy Wall	35
	T-Junction - Intertenancy Wall meeting External Wall	36
	T-Junction - Intertenancy Wall meeting Internal Corner	37
	Mid-floor	38
	Roof Valley	39
	Roof Ridge	40
	Roof Parapet	41
	Sloping Roof End	42
	Eave	43

Name	FRR	STC	Rw	Linings	Structure	Page
INTA120a	120/120/120	64*1	62*2	1 layer of 10mm Plasterboard	Timber	16
INTA120b	120/120/120	66	65	1 layer of 13mm Plasterboard	Timber	17
INTA120c	120/120/120	67*1	66*2	2 layers of 10mm Plasterboard	Timber	18
INTA120d	120/120/120	66	65	1 layer of 10mm Noise Rated Plasterboard	Timber	19
INTA120e	120/120/120	67	67	1 layer of 13mm Noise Rated Plasterboard	Timber	20
INSA120a	120/120/120	64	62	1 layer of 10mm Plasterboard	Steel	21
INSA120b	120/120/120	66	65	1 layer of 13mm Plasterboard	Steel	22
INSA120c	120/120/120	67	66	2 layers of 10mm Plasterboard	Steel	23
INSA120d	120/120/120	66	65	1 layer of 10mm Noise Rated Plasterboard	Steel	24
INSA120e	120/120/120	67	67	1 layer of 13mm Noise Rated Plasterboard	Steel	25

* Tested in accordance with ISO standard 10140-2:2010(E) "Laboratory measurement of sound insulation of building elements - Part 2: Measurement of airborne sound insulation"

1. Determined in accordance with ASTM E413 Classification for Rating Sound Insulation
2. Determined in accordance with ISO 717-1 Acoustics – Rating of sound insulation in buildings and of building elements – Part 1: Airborne sound insulation

All other values calculated

1. General System Description

The INTEGRA Lightweight Concrete Intertency System is a proprietary high-performance wall system that provides horizontal fire and acoustic separation between adjacent tenancies in the same building. The core component of the INTEGRA system is a high-tech lightweight concrete panel and intertenancy bracket that is installed between framing that has insulation and plasterboard lining on the outer face.

A cavity is created between the INTEGRA lightweight concrete and the framing through the use of a proprietary Intertency Bracket and Dampener.

The INTEGRA Lightweight Concrete Intertency System is suitable for the use in medium and high-density housing i.e. Terraced Housing

2. Terminology

Find below explanations of some of the acronyms that are used throughout this document, for further information you can refer to the Building Code Handbook for additional definitions this can be found at the following link.

<https://www.building.govt.nz/building-code-compliance/building-code-and-handbooks/building-code-handbook/>

AS – Acceptable Solution or Australia Standard

FRR – Fire Resistance Rating

FSTC – Field Sound Transmission Class

NZBC – New Zealand Build Code

NZS – New Zealand Standard

STC – Sound Transmission Class represents a single number system for quantifying the transmission loss through a building element. STC is based upon typical speech and domestic noises, and thus is most applicable to these areas. STC of a building element is measured in approved testing laboratories under ideal conditions.

FSTC - The 'field' or in situ measurement of Sound Transmission Class. Building tolerances and flanking noise have an effect on the performance of a partition when it is actually installed, which result in FSTC values lower than the laboratory derived STC values, typically 5 dB less.

Rw - Sound Reduction Index is a number used to rate the effectiveness of a soundproofing system or material

IIC – Impact Insulation Class measures a floor assembly's ability to absorb impact sound

FIIC - The 'field' or in situ measurement of Impact Insulation Class. Building tolerances and flanking noise have an effect on the performance of a partition when it is actually installed, which result in FIIC values lower than the laboratory derived IIC values, typically 5 dB less.

SG – Stress Grade

PPE – Personal Protective Equipment

VM – Verification Method

AS1530.4-2005 – Methods for fire tests on building materials, components and structures, Part 4: Fire-resistance tests of elements of construction.

Sound Insulation - When sound hits a surface, some of the sound energy travels through the material. 'Sound insulation' refers to ability of a material to stop sound travelling through it.

Impact Sound - Sound produced by an object impacting directly on a building structure, such as footfall noise or chairs scrapping on a floor.

Flanking Paths/Transmission - Transmission of sound energy through paths adjacent to the building element being considered. For example, sound may be transmitted around a wall by travelling up into the ceiling space and then down into the adjacent room.

Structure-Borne Transmission - The transmission of sound from one space to another through the structure of a building.

3. Specification Reference Labelling

The specification label reference allows a quick reference to a system.

For example

INTA120a

IN = 50mm Integra Panel

T = Timber Frame

A = Acoustic

120 = Fire Resistance Rating

a/b/c/d/e = System Options

4. Product Substitution

The INTEGRA Lightweight Concrete Intertency System is a proprietary system that has been carefully designed to New Zealand conditions and has been independently tested and assessed to make sure that it meets the performance criteria as outlined in the NZBC. It is imperative to use only Resene Construction Systems proprietary products where specified and that the design and construction of the Intertency System is followed so that you are safe in the knowledge that the level of fire safety, structural and sound performance has been achieved on site.

5. Components not supplied

Plasterboard Linings

The lining to each face of the wall may be any gypsum based plasterboard of at least 10mm thick.

Thermal/Acoustic insulation

The inclusion of thermal/acoustic insulation in the wall cavities should be either fibreglass, polyester, wool or wool blend.

- Thermally insulate framed walls.
- Fit easily into standard wall constructions, or be easily cut to fit in non-standard constructions.
- Meet the requirements of the New Zealand Building Code (NZBC) for different designs and environments

6. Scope of use for the INTEGRA Lightweight Concrete Intertency System

INTEGRA Lightweight Concrete Intertency System can be used: -

- Where a Fire Resistance Rating up to 120/120/120 is required.
- Where a minimum STC of at least 55 is required
- Where a maximum loading of 4.5kN/Stud is required
- Where an Intertency Wall is up to 12m in height, studs will need to be increased to meet the structural design requirements
- Where a maximum individual floor/ceiling height meets NZS 3604 or if Steel Framing (NASH Handbook Best Practice for Design and Construction of Residential and Low Rise Steel Framing).
- For medium and high-density housing i.e. Terraced Housing
- Where timber or steel studs are specified and are rated to carry the imposed load per stud

The designer should consider the various systems depending on the acoustic and fire performance that is required. The designer should factor in the following:

- Height of the wall
- Cavity size (typically 20mm)
- Potential building movement, earthquake zones
- Any lateral loads
- Any floor loads must be carried solely by the timber framing (i.e. no contact with floor joists and INTEGRA Lightweight Concrete Panels)
- That the framing needs to be designed for the individual project

7. Cavity Size

The INTEGRA Lightweight Concrete Intertency System has been designed to utilise a cavity air space of between 20mm - 40mm. This cavity is formed between the framing and the Integra Panel central barrier on both sides of the Intertency Wall.

8. Compliance with the NZBC

B1 – Structure

The design and specification for timber framing must be in accordance with the performance requirements of NZBC B1. Framing used in accordance with NZS3604:2011 is compliant in accordance with NZBC B1 and is the best choice to use when using the INTEGRA Lightweight Concrete Intertency System. Where the framing falls outside the requirements of NZS3604:2011 we recommend that an engineer is engaged to ensure that structural compliance is met. If Steel Framing is used then E2/AS4 NASH Handbook Best Practice for Design and Construction of Residential and Low Rise Steel Framing should be used.

The INTEGRA Lightweight Concrete panels performs NO STRUCTURAL FUNCTION and that the two timber framed walls forms part of the overall system and must be designed to independently accommodate all the relevant gravity, lateral and face loads that will be present in the building. In relation to the design of the timber framing, the framing must be designed in accordance with B/AS1 3.0 Timber (NZS 3604) or B/VM1 6.0 Timber (NZS 3603) or if Steel Framing (E2/AS4 NASH Handbook Best Practice for Design and Construction of Residential and Low Rise Steel Framing).

The INTEGRA Lightweight Concrete Intertency System can be used on either a loadbearing or non-loadbearing wall. The INTEGRA central barrier within the wall system should be treated as non-loadbearing.

During construction provision should be made for temporary bracing particularly if the panel could be subjected to a high wind load or when installing panel continuously over a single storey in height where the second framed walls has not been installed.

B2 – Durability

Under normal conditions of internal use, the INTEGRA Lightweight Concrete Intertency System will achieve a service life in excess of 50 years and satisfy the requirements of NZBC B2.

C1-C6 – Protection from Fire

The INTEGRA Lightweight Concrete Intertency System can be used to provide passive fire protection in accordance with the requirement of NZBC C1-C6 – Protection from Fire. The INTEGRA Lightweight Concrete Intertency System has been peer reviewed and meets the provisions of NZBC C1-C6 when kept within the scope as outlined in Section 6 - Scope of use for the INTEGRA Lightweight Concrete Intertency System.

The INTEGRA Lightweight Concrete Intertency System has been designed for one side to collapse in a fire, leaving the central barrier and the opposing wall in place. The INTEGRA Lightweight Concrete Intertency System Brackets are intended to melt on the fire side only, allowing collapse without damage to the remaining system.

The fire resistance rating has been established through a full-scale fire test at BRANZ. This fire report is available on request.

Fire Cells and Fire Resistance Ratings

1. The fire engineer for the project will determine where the fire cells are in the building and what fire resistance ratings (FRRs) are required.
2. In most cases, an INTEGRA Lightweight Concrete Intertency wall will form the common wall of a fire cell between adjacent tenancies and will require a two-way FRR.
3. The INTEGRA Lightweight Concrete Intertency System has been tested in accordance with AS 1530.4: 2014 and achieves a 120 / 120 / 120 minute FRR.
4. The elements of the FRR required will depend on the specific scenario in the building in question. For example, if fire sprinklers are present and the wall is non-loadbearing, the INTEGRA Lightweight Concrete Intertency System may not require structural adequacy or insulation ratings, i.e. the INTEGRA Lightweight Concrete Intertency System is only required to provide a - / 120 / - FRR.

5. Specific requirements are contained within the Acceptable Solution document that applies to the building in question

Control of Internal Fire and Smoke Spread

1. Where the INTEGRA Lightweight Concrete Intertency System is loadbearing, the plasterboard and framing on the fire side of the INTEGRA panels will have to achieve the specified FRR, independent of the INTEGRA panels, to achieve structural stability during fire. This will also require any services penetration through the plasterboard to be fire stopped – specialist advice will be required from the fire engineer in this case.
2. In some applications, the finished INTEGRA Lightweight Concrete Intertency System will be required to achieve a material group number rating, which will be specified by the fire engineer. Table A1 in C/VM2 specifies that paper-faced gypsum plasterboard that is ≥ 9.5 mm thick, ≥ 400 kg/m³ core density, < 5 % organic contribution to board, and with a waterborne or solvent based paint coating of ≤ 0.4 mm thick, will achieve a group number G2-S rating.
3. It is also very important that the FRR of the INTEGRA Lightweight Concrete Intertency System is not compromised at the junction to fire rated floors (at base of wall) and floors/ceilings (at top of wall), and where concealed spaces and cavities occur.

Control of external fire spread

1. In situations where the INTEGRA system forms part of an external wall, the fire engineer for the project will specify aspects such as the required FRRs and percentage of unprotected openings.
2. Exterior surface finish requirements will apply where the INTEGRA panel is the external cladding for the building

F2 – Hazardous Building Materials

Under normal conditions of internal use, the INTEGRA Lightweight Concrete Intertency

System does not constitute a health hazard and meets the provisions of the NZBC Clause F2.

G6 – Airborne and Impact Sound

The INTEGRA Lightweight Concrete Intertency System provides airborne noise control ratings that exceed the minimum requirements of NZBC Clause G6 – Airborne and Impact Sound. The INTEGRA Lightweight Concrete Intertency System has been peer reviewed and meets the provisions of NZBC G6 when kept within the scope (Section 6 - Scope of use for the INTEGRA Lightweight Concrete Intertency System).

The STC ratings have been established through a full-scale sound test at Auckland University. These reports are available on request.

The INTEGRA wall system does not require an STC rating when used within a roof/uninhabitable space.

Any rigid air barriers that bridge over an Intertency Wall should be discontinued at this point and a flexible underlay installed.

Ensure that any brackets installed on the framed wall are NOT mirrored on the second wall, the brackets on the second wall should be installed on opposing studs or where they are at least 300mm apart from each other.

9. Services

Under no circumstances should any services penetrate the INTEGRA Lightweight Concrete panels. Services may however be concealed within the framed section of the wall system, subject to the following constraints.

- A minimum of 10mm clearance should be maintained between any penetrations and the central barrier.
- Penetrations should be no larger than 65mm diameter or 90×50mm through the plasterboard lining. There is no requirement to firestop these penetrations.
- That no more than 2 penetrations per 600mm bay of framing are made.

10. Exposure to weather during construction

The INTEGRA Lightweight Concrete Intertency System can be exposed to the elements for up to 3 months before the building is closed in.

Should the wall be exposed to the weather for a longer period then we recommend applying Resene Aquapel over the entire surface of the INTEGRA Lightweight Concrete Panels.

11. Materials

Fasteners

INTEGRA Lightweight Concrete Intertency System Screws must be used; these are available in the following sizes for both timber and steel framing

- 12gx75mm Galvanised with EPDM Washer
- Used to secure the Integra Panel to the Intertency Bracket
- 12gx45mm Galvanised with EPDM Washer
- Used to secure the Intertency Bracket to the structure

Intertency Bracket

- Aluminium bracket
- Supplied in boxes of 50 brackets including the above fasteners.
- 50mm wide
- 3mm Thick
- 75mm x 50mm legs
- Includes a sound and heat resistant dampener with spacers to limit contact to the surface being attached to

INTEGRA Panel Central Barrier

- Thermal Conductivity: 0.12 W/(mk)
- Thermal Resistivity, R: 0.42m²K/W

- Substrate Thickness: 50mm
- Weight: 26kg/m², 34kg per panel
- 2200mm long, 600mm wide
- Non-Combustible (AS1530.1-1994)

PSL AAC Adhesive

- Supplied in 20kg bags
- Used for bonding AAC together, patching panel, and securing the panel to a concrete foundation

Anti-Corrosion Coating

- Use to prime any exposed steel that may be exposed when the INTEGRA panel is cut to length or width
- Zinc Rich protective Coating such as Wurth Zinc Spray Light Perfect

Wall Insulation

In order to achieve the stated ratings the acoustic absorption product would need to be fibrous (glass fibre, polyester fibre or wool) and would need to have a minimum thickness of 75 mm.

- Thermally insulate timber framed walls.
- Fit easily into standard wall constructions, or be easily cut to fit in non-standard constructions.
- Meet the requirements of the New Zealand Building Code (NZBC) for different designs and environments

12. System Variations

- Increasing the thickness of the panel from 50mm to 75mm
- Increase in timber density
- Increase in cross-sectional dimension of the framing element(s)
- Decrease in stud spacing
- Replace the timber studs with steel studs of equivalent structural strength to carry the imposed load per stud

13. Installation Guidelines

General

Before commencing any work onsite, ensure the site is clean and tidy. Where possible try and minimise any vibration or impact directly or indirectly on the INTEGRA during installation this will assist with minimising mortar between panels being broken before it cures/sets

Step 1- Framing

All framing should be installed as specified in the construction drawings and should be straight and plumb. The INTEGRA system requires framing to be set out in accordance with NZS3604:2011 for timber frames or E2/AS4 (NASH Handbook: Best Practice for Design and Construction of Residential and Low-Rise Steel Framing) for steel framed walls.

Install the framing to one side of the Intertency Wall first.

It is recommended to install strapping tape to the framing prior to installing the central barrier to ensure the insulation is held in place.

Step 2 - Installation of brackets

You will need two brackets per panel with spacing governed by stud centres (approximately 1 bracket per lineal metre) of wall to secure a row of panel to one frame.

Starting at one end of the framing, install a bracket to the end stud so that it is located 300mm from the Finished Floor Level. Ensure that the face of the dampener on the bracket has been installed 20-40mm (depending on the specified cavity size) off the line of the framing.

Use the Resene Construction Systems 12x45mm Galvanised screw with EPDM Washer to secure the Intertency Bracket to the structure.

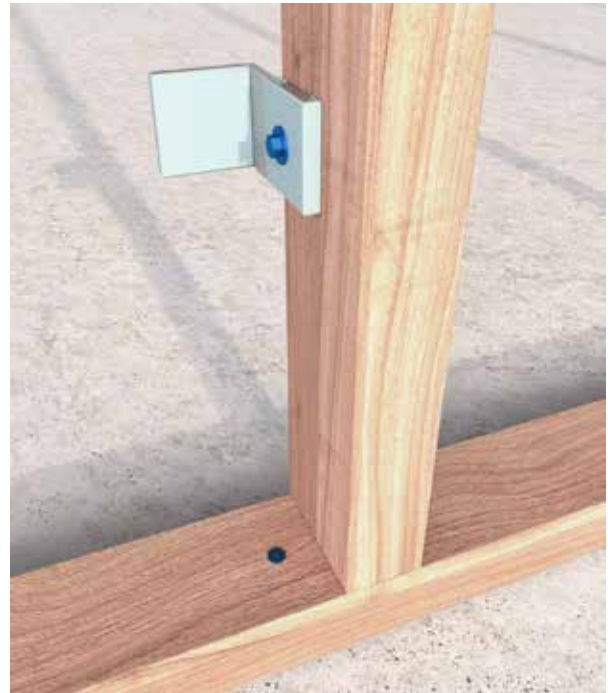

Image 1 – Bracket located 300mm off the Floor

Every second stud should have a bracket installed in the same location. The use of a string line will help to ensure your brackets are kept straight.



Image 2 – Bottom Row of Brackets installed

Once you have located the first row of panels you can continue to install brackets at 600 centres up the stud starting from the first bracket to the stud. A useful way to do this is to install the bottom and top brackets on the wall and then use a straight edge to align the brackets and ensure they are all on the same plane. You can use a level to ensure these are installed in a plumb position.



Image 3 – Brackets installed to wall

Step 3 - Mixing and Application of mortar, install the bottom row of Integra panel

Mix up 2-3 kg's of Resene Construction Systems PSL AAC Adhesive to get you started, mix to a smooth consistency and when you can run your finger through it and the plaster remains standing you are ready to apply it (approximately 4 litres of water per 20kg bag)

The first row of panels must be bedded to the concrete floor slab using AAC Adhesive. To do this, apply AAC Adhesive to the long edge of an Integra Panel using a spatula/broad-knife.



Image 4 – Mortar to bottom of Panel

Then lift and position the panel so that it is installed horizontally and is resting against two brackets in a plumb position. Ensure that there are no gaps between the panel and the floor slab.



Image 5 – First Panel in place

Step 4 - Installation of Integra Panel in the wall cavity

Continue along the length of the wall installing the Integra panel to form the central barrier. Ensure that vertical edge of the panels is bonded together using the AAC Adhesive.



Image 6 – First row of panel installed

Ensure that all full-length panels have 2 clips per panel to secure the panel to one side of the framing. Where you have a section of panel that is less than 600mm then no bracket is required, you can rely on the AAC adhesive to bond the panels together where this occurs.

Any panels can be cut onsite using a circular saw equipped with a diamond tipped blade. Ensure that a dust extraction unit is used as well as PPE (including glasses, dust masks, hearing protection and gloves).

Any steel reinforcement that is exposed during the cutting must be coated with an anti-corrosion coating.

Any minor damage should be patched using the AAC Adhesive; this will ensure the acoustic performance and fire protection is maintained.

Step 5 - Screw fixing the panels to the brackets

As each panel is positioned, secure it to the corresponding intertenancy brackets. The screw is installed blind from the far side of the panel. To do this drill a 2-3mm pilot hole through the existing hole in the Intertenancy bracket and through the Integra Panel Central barrier.



Image 7 – Drill a pilot hole through the panel

Use a Resene Construction Systems 12x75mm Galvanised screw with EPDM Washer to secure the Integra Panel to the Intertenancy Bracket through the pilot hole you have drilled.



Image 8 – Screw through the panel into the bracket

Continue to install the central barrier of Integra Panel in a stacker bond pattern (each sheet on top of each other so that the joints align) using the AAC Adhesive to bond the panels together.



Image 9 – Panel installed in a Stacker Bond pattern

Step 6 – Install the framing to the other side of the central barrier

Once you have installed the central barrier 4 panels high it is recommended to install the wall on the other side of the barrier. Once this is installed the brackets can be installed. The brackets should be installed so that they are not directly opposite the brackets on the opposing side.



Image 10 – Brackets shown on different studs on opposite walls

Step 7 - Installation of services

Ensure you sequence the installation of your services so that you minimise the amount of penetrations through the framing. Under no circumstances is the INTEGRA Panel central barrier to be penetrated with a service. The best time to install the services is once the Integra Panel central barrier has been completed.

Step 8 - Installation of Insulation

The installation of the insulation should be completed as per the manufacturer's specifications. The insulation must completely fill the space between the framing. If there is any gaps between the insulation and framing then the acoustic performance will be compromised. When installing the insulation please ensure that it is not pushed back against the central barrier. It is recommended to install strapping tape to the framing prior to installing the central barrier to ensure the insulation is held in place.

Step 9 - Installation and finishing of Plasterboard

Plasterboard can be fixed either vertically or horizontally. Sheets shall be touch fitted. When fixing vertically, full height sheets shall be used where possible. All sheet joints must be formed over solid timber framing.

A bead of acoustic sealant is required around the perimeter of the wall lining.

If the wall lining forms part of the structural bracing system, the lining type and fixings must comply with the published bracing system. Check requirements for specific bracing element hold down connections.

Jointing and finishing of plasterboard is to be as per the manufacturer's instructions to meet requirements of AS/NZS 2589:2017.

Step 10 - Finishing services

Any gaps through the plasterboard should be sealed using an acoustic rated sealant. The installation of the sealant should be completed in accordance with the manufacturer's specifications.

If the framing is loadbearing (i.e. supporting a floor from a different fire cell) then all service penetrations will need to be fire stopped. Please consult with your fire engineer around the best method of doing this.

Special Notes when installing with Steel Framing

There will be occasions with Steel Framing setouts where a small proportion of the wall has no insulation installed in the voids of the steel framing. We can verify that the rating of the wall will not be compromised by the framing arrangement at the junctions. However we recommend that where two such details (for example T-Junction - Internal Wall meeting Intertency Wall and Corner - Internal Linings both Sides) are located within 1.8 metres of each other that fibrous insulation is placed within the steel stud cavity or the details are reviewed by an acoustic engineer.

INTA120a - Timber Frame – 120 minute - INTEGRA Lightweight Concrete with 1 layer of 10mm Standard Plasterboard to both framing lines

Framing to comply with

- NZBC B1 – Structure: AS1 Clause 3 – Timber (NZS 3604) or VM1 Clause 6 – Timber (NZS 3603)
- NZBC B2 – Durability: AS1 Clause 3.2 – Timber (NZS 3602)
- Studs at 600mm centres maximum
- Nogs/Dwangs at 800mm centres
- Framing dimensions and height as determined by NZS 3604 stud and top plate tables for loadbearing walls.

Barrier to comply with

- NZBC Clause B1 Structure
- NZBC Clause B2 Durability
- NZBC Clause C1-C6 – Protection from Fire
- NZBC Clause F2 Hazardous Building Materials
- NZBC Clause G6 Airborne and Impact Sound

Linings

- 1 layer of 10mm Standard Plasterboard on the outside of each framing line.
- Vertical fixing permitted. Sheets shall be touch fitted.
- When fixing vertically, full height sheets shall be used where possible.
- All sheet joints must be formed over solid timber framing.
- If the wall lining forms part of the structural bracing system, the lining type and fixings must comply with the published bracing system. Check requirements for specific bracing element hold down connections.

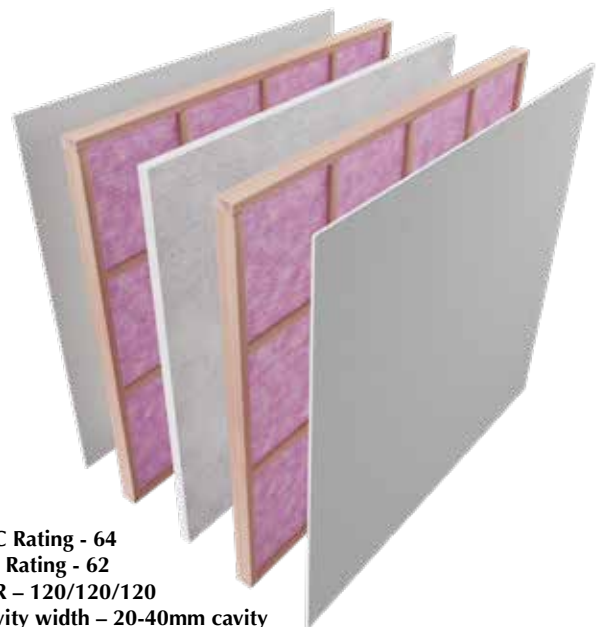

STC Rating - 64
Rw Rating - 62
FRR – 120/120/120
Cavity width – 20-40mm cavity
Wall Width – 290-330mm

Lining Fixings

- 32mm x 6g Drywall Screws
- Lining Fastener Centres 300mm centres to each stud and plate.
- Place fasteners 12mm from bound sheet edges and 18mm from sheet ends.
- If fixing sheets horizontally, fasteners to be placed at 300mm centres to top and bottom plates and perimeter studs. Install pairs of single fasteners to each stud where horizontal joint crosses.

Acoustic Sealant

- A bead of acoustic sealant is required around the perimeter of the wall lining.

Jointing

- Jointing and finishing of plasterboard is to be as per the manufacturer's instructions to meet requirements of AS/NZS 2589:2017.

INTA120b - Timber Frame – 120 minute - INTEGRA Lightweight Concrete with 1 layer of 13mm Standard Plasterboard to both framing lines

Framing to comply with

- NZBC B1 – Structure: AS1 Clause 3 – Timber (NZS 3604) or VM1 Clause 6 – Timber (NZS 3603)
- NZBC B2 – Durability: AS1 Clause 3.2 – Timber (NZS 3602)
- Studs at 600mm centres maximum
- Nogs/Dwangs at 800mm centres
- Framing dimensions and height as determined by NZS 3604 stud and top plate tables for loadbearing walls.

Barrier to comply with

- NZBC Clause B1 Structure
- NZBC Clause B2 Durability
- NZBC Clause C1-C6 – Protection from Fire
- NZBC Clause F2 Hazardous Building Materials
- NZBC Clause G6 Airborne and Impact Sound

Linings

- 1 layer of 13mm Standard Plasterboard on the outside of each framing line
- Vertical fixing permitted. Sheets shall be touch fitted.
- When fixing vertically, full height sheets shall be used where possible.
- All sheet joints must be formed over solid timber framing.
- If the wall lining forms part of the structural bracing system, the lining type and fixings must comply with the published bracing system. Check requirements for specific bracing element hold down connections.

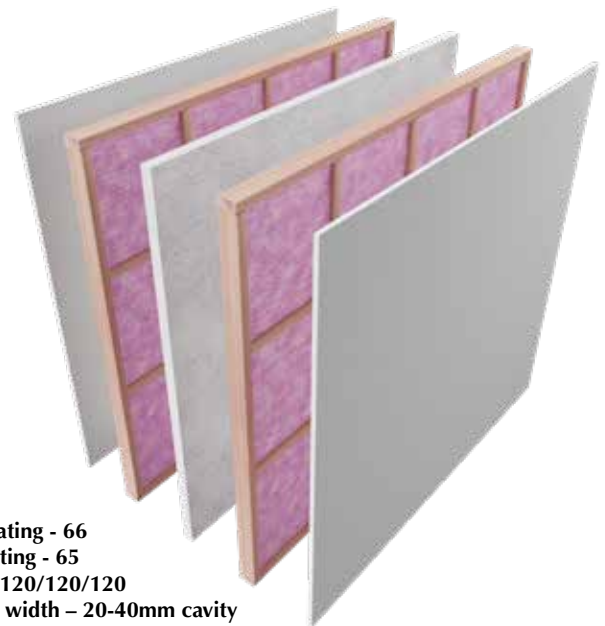

STC Rating - 66
Rw Rating - 65
FRR – 120/120/120
Cavity width – 20-40mm cavity
Wall Width – 296-336mm

Lining Fixings

- 32mm x 6g Drywall Screws
- Lining Fastener Centres 300mm centres to each stud and plate.
- Place fasteners 12mm from bound sheet edges and 18mm from sheet ends.
- If fixing sheets horizontally, fasteners to be placed at 300mm centres to top and bottom plates and perimeter studs. Install pairs of single fasteners to each stud where horizontal joint crosses.

Acoustic Sealant

- A bead of acoustic sealant is required around the perimeter of the wall lining.

Jointing

- Jointing and finishing of plasterboard is to be as per the manufacturer's instructions to meet requirements of AS/NZS 2589:2017.

INTA120c - Timber Frame – 120 minute - INTEGRA Lightweight Concrete with 2 layers of 10mm Standard Plasterboard to both framing lines

Framing to comply with

- NZBC B1 – Structure: AS1 Clause 3 – Timber (NZS 3604) or VM1 Clause 6 – Timber (NZS 3603)
- NZBC B2 – Durability: AS1 Clause 3.2 – Timber (NZS 3602)
- Studs at 600mm centres maximum
- Nogs/Dwangs at 800mm centres
- Framing dimensions and height as determined by NZS 3604 stud and top plate tables for loadbearing walls.

Barrier to comply with

- NZBC Clause B1 Structure
- NZBC Clause B2 Durability
- NZBC Clause C1-C6 – Protection from Fire
- NZBC Clause F2 Hazardous Building Materials
- NZBC Clause G6 Airborne and Impact Sound

Linings

- 2 layers of 10mm Standard Plasterboard on the outside of each framing line
- Vertical fixing permitted. Sheets shall be touch fitted.
- When fixing vertically, full height sheets shall be used where possible.
- All sheet joints must be formed over solid timber framing.
- Outer layer sheets can be fixed vertically or horizontally. If fixed vertically, outer layer sheet joints must be offset 600mm from those of the inner layer. Use full height sheets where possible.
- If the wall lining forms part of the structural bracing system, the lining type and fixings must comply with the published bracing system. Check requirements for specific bracing element hold down connections.

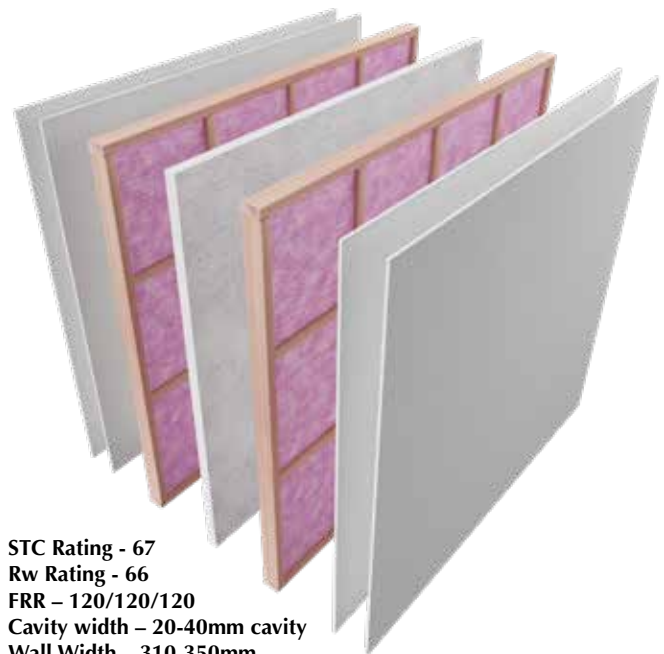

STC Rating - 67
Rw Rating - 66
FRR – 120/120/120
Cavity width – 20-40mm cavity
Wall Width – 310-350mm

Lining Fixings

- Inner Layer: 32mm x 6g Drywall Screws
- Outer Layer: 41mm x 6g Drywall Screws
- Place fasteners 12mm from bound sheet edges and 18mm from sheet ends.
- Fix inner sheets vertically. Where sheet end butt joints are unavoidable they must be formed over framing. Use full height sheets where possible.
- Outer layer: If fixing sheets horizontally, fasteners to be placed at 300mm centres to top and bottom plates and perimeter studs. Install pairs of single fasteners to each stud where horizontal joint crosses. Adhesive fix the outer layer to the inner layer with daubs of plasterboard adhesive at 300mm centres. Do not place plasterboard adhesive at sheet edges or within 200mm of screw fixings.

Acoustic Sealant

- A bead of acoustic sealant is required around the perimeter of the inner wall lining.

Jointing

- Jointing and finishing of plasterboard is to be as per the manufacturer's instructions to meet requirements of AS/NZS 2589:2017.

INTA120d - Timber Frame – 120 minute - INTEGRA Lightweight Concrete with 1 layer of 10mm Noise Rated Plasterboard to both framing lines

Framing to comply with

- NZBC B1 – Structure: AS1 Clause 3 – Timber (NZS 3604) or VM1 Clause 6 – Timber (NZS 3603)
- NZBC B2 – Durability: AS1 Clause 3.2 – Timber (NZS 3602)
- Studs at 600mm centres maximum
- Nogs/Dwangs at 800mm centres
- Framing dimensions and height as determined by NZS 3604 stud and top plate tables for loadbearing walls.

Barrier to comply with

- NZBC Clause B1 Structure
- NZBC Clause B2 Durability
- NZBC Clause C1-C6 – Protection from Fire
- NZBC Clause F2 Hazardous Building Materials
- NZBC Clause G6 Airborne and Impact Sound Linings

Linings

- 1 layer of 10mm Noise Rated Plasterboard on the outside of each framing line
- Vertical fixing permitted. Sheets shall be touch fitted.
- When fixing vertically, full height sheets shall be used where possible.
- All sheet joints must be formed over solid timber framing.
- If the wall lining forms part of the structural bracing system, the lining type and fixings must comply with the published bracing system. Check requirements for specific bracing element hold down connections.

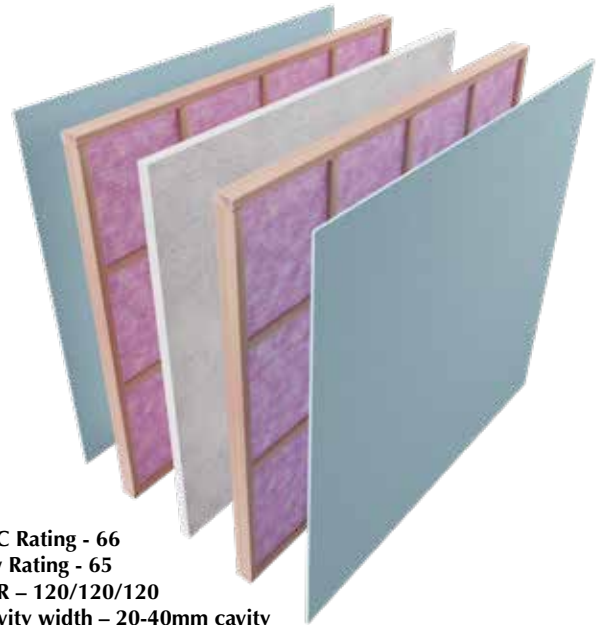

STC Rating - 66
Rw Rating - 65
FRR – 120/120/120
Cavity width – 20-40mm cavity
Wall Width – 290-330mm

Lining Fixings

- 32mm x 6g Drywall Screws
- Lining Fastener Centres 300mm centres to each stud and plate.
- Place fasteners 12mm from bound sheet edges and 18mm from sheet ends.
- If fixing sheets horizontally, fasteners to be placed at 300mm centres to top and bottom plates and perimeter studs. Install pairs of single fasteners to each stud where horizontal joint crosses.

Acoustic Sealant

- A bead of acoustic sealant is required around the perimeter of the wall lining.

Jointing

- Jointing and finishing of plasterboard is to be as per the manufacturer's instructions to meet requirements of AS/NZS 2589:2017.

INTA120e - Timber Frame – 120 minute - INTEGRA Lightweight Concrete with 1 layer of 13mm Noise Rated Plasterboard to both framing lines

Framing to comply with

- NZBC B1 – Structure: AS1 Clause 3 – Timber (NZS 3604) or VM1 Clause 6 – Timber (NZS 3603)
- NZBC B2 – Durability: AS1 Clause 3.2 – Timber (NZS 3602)
- Studs at 600mm centres maximum
- Nogs/Dwangs at 800mm centres
- Framing dimensions and height as determined by NZS 3604 stud and top plate tables for loadbearing walls.

Barrier to comply with

- NZBC Clause B1 Structure
- NZBC Clause B2 Durability
- NZBC Clause F2 Hazardous Building Materials Linings

Linings

- 1 layer of 13mm Noise Rated Plasterboard on the outside of each framing line
- Vertical fixing permitted. Sheets shall be touch fitted.
- When fixing vertically, full height sheets shall be used where possible.
- All sheet joints must be formed over solid timber framing.
- If the wall lining forms part of the structural bracing system, the lining type and fixings must comply with the published bracing system. Check requirements for specific bracing element hold down connections.

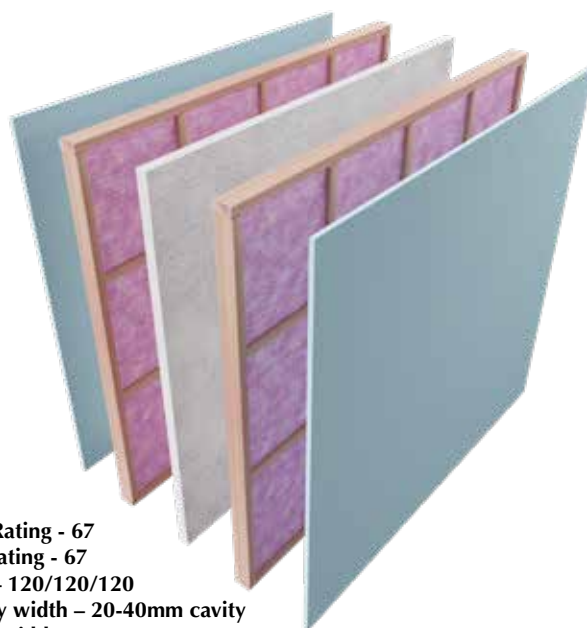

STC Rating - 67
Rw Rating - 67
FRR – 120/120/120
Cavity width – 20-40mm cavity
Wall Width – 296-336mm

Lining Fixings

- 32mm x 6g Drywall Screws
- Lining Fastener Centres 300mm centres to each stud and plate.
- Place fasteners 12mm from bound sheet edges and 18mm from sheet ends.
- If fixing sheets horizontally, fasteners to be placed at 300mm centres to top and bottom plates and perimeter studs. Install pairs of single fasteners to each stud where horizontal joint crosses.

Acoustic Sealant

- A bead of acoustic sealant is required around the perimeter of the wall lining.

Jointing

- Jointing and finishing of plasterboard is to be as per the manufacturer's instructions to meet requirements of AS/NZS 2589:2017.

INSA120a - Steel Frame – 120 minute - INTEGRA Lightweight Concrete with 1 layer of 10mm Standard Plasterboard to both framing lines

Framing to comply with

- NZBC B1 – Structure
- NZBC B2 – Durability
- Studs at 600mm centres maximum
- Nogs/Dwangs at 1200mm centres
- Framing dimensions and height as determined by E2/AS4 (NASH Handbook Best Practice for Design and Construction of Residential and Low Rise Steel Framing)

Barrier to comply with

- NZBC Clause B1 Structure
- NZBC Clause B2 Durability
- NZBC Clause C1-C6 – Protection from Fire
- NZBC Clause F2 Hazardous Building Materials
- NZBC Clause G6 Airborne and Impact Sound

Linings

- 1 layer of 10mm Standard Plasterboard on the outside of each framing line
- Vertical fixing permitted. Sheets shall be touch fitted.
- When fixing vertically, full height sheets shall be used where possible.
- All sheet joints must be formed over solid framing.
- If the wall lining forms part of the structural bracing system, the lining type and fixings must comply with the published bracing system. Check requirements for specific bracing element hold down connections.

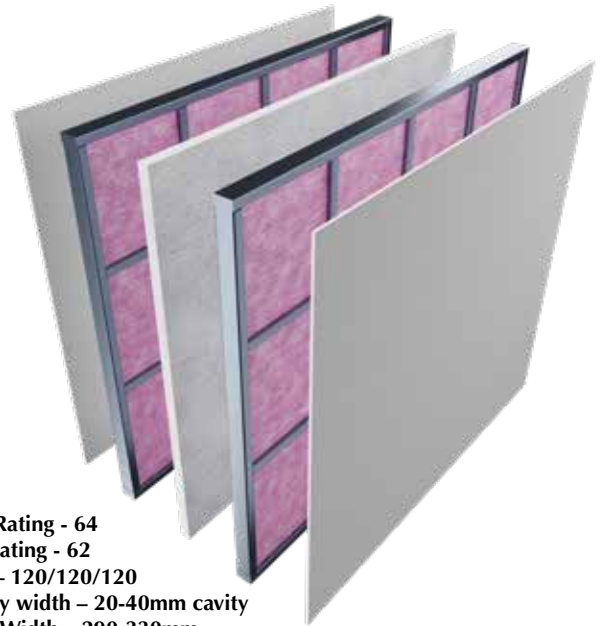

STC Rating - 64
Rw Rating - 62
FRR – 120/120/120
Cavity width – 20-40mm cavity
Wall Width – 290-330mm

Lining Fixings

- 25mm x 6g Self Tapping Drywall Screws
- Lining Fastener Centres 300mm centres to each stud and plate.
- Place fasteners 12mm from bound sheet edges and 18mm from sheet ends.
- If fixing sheets horizontally, fasteners to be placed at 300mm centres to top and bottom plates and perimeter studs. Install pairs of single fasteners to each stud where horizontal joint crosses.

Acoustic Sealant

- A bead of acoustic sealant is required around the perimeter of the wall lining

Jointing

- Jointing and finishing of plasterboard is to be as per the manufacturer's instructions to meet requirements of AS/NZS 2589:2017.

INSA120b - Steel Frame – 120 minute - INTEGRA Lightweight Concrete with 1 layer of 13mm Standard Plasterboard to both framing lines

Framing to comply with

- NZBC B1 – Structure
- NZBC B2 – Durability
- Studs at 600mm centres maximum
- Nogs/Dwangs at 1200mm centres
- Framing dimensions and height as determined by E2/AS4 (NASH Handbook Best Practice for Design and Construction of Residential and Low Rise Steel Framing)

Barrier to comply with

- NZBC Clause B1 Structure
- NZBC Clause B2 Durability
- NZBC Clause C1-C6 – Protection from Fire
- NZBC Clause F2 Hazardous Building Materials
- NZBC Clause G6 Airborne and Impact Sound

Linings

- 1 layer of 13mm Standard Plasterboard on the outside of each framing line
- Vertical fixing permitted. Sheets shall be touch fitted.
- When fixing vertically, full height sheets shall be used where possible.
- All sheet joints must be formed over solid framing.
- If the wall lining forms part of the structural bracing system, the lining type and fixings must comply with the published bracing system. Check requirements for specific bracing element hold down connections.

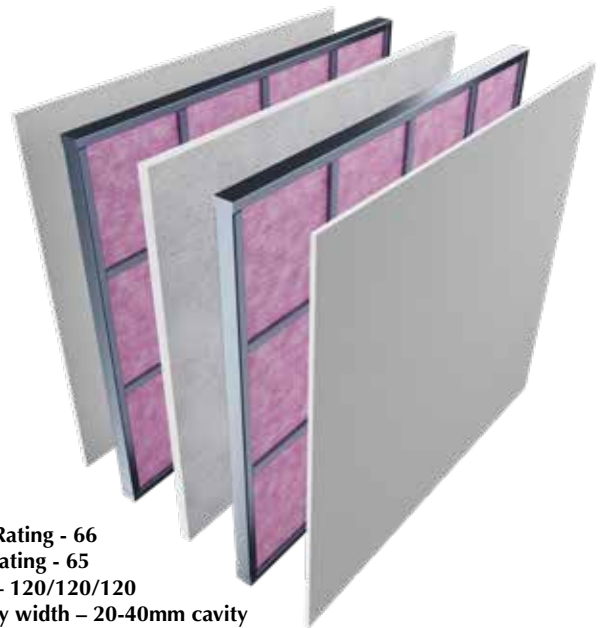

STC Rating - 66
Rw Rating - 65
FRR – 120/120/120
Cavity width – 20-40mm cavity
Wall Width – 296-336mm

Lining Fixings

- 25mm x 6g Self Tapping Drywall Screws
- Lining Fastener Centres 300mm centres to each stud and plate.
- Place fasteners 12mm from bound sheet edges and 18mm from sheet ends.
- If fixing sheets horizontally, fasteners to be placed at 300mm centres to top and bottom plates and perimeter studs. Install pairs of single fasteners to each stud where horizontal joint crosses.

Acoustic Sealant

- A bead of acoustic sealant is required around the perimeter of the wall lining

Jointing

- Jointing and finishing of plasterboard is to be as per the manufacturer's instructions to meet requirements of AS/NZS 2589:2017.

INSA120c - Steel Frame – 120 minute - INTEGRA Lightweight Concrete with 2 layers of 10mm Standard Plasterboard to both framing lines

Framing to comply with

- NZBC B1 – Structure
- NZBC B2 – Durability
- Studs at 600mm centres maximum
- Nogs/Dwangs at 1200mm centres
- Framing dimensions and height as determined by E2/AS4 (NASH Handbook Best Practice for Design and Construction of Residential and Low Rise Steel Framing)

Barrier to comply with

- NZBC Clause B1 Structure
- NZBC Clause B2 Durability
- NZBC Clause C1-C6 – Protection from Fire
- NZBC Clause F2 Hazardous Building Materials
- NZBC Clause G6 Airborne and Impact Sound

Linings

- 2 layers of 10mm Standard Plasterboard on the outside of each framing line
- Vertical fixing permitted. Sheets shall be touch fitted.
- When fixing vertically, full height sheets shall be used where possible.
- All sheet joints must be formed over solid framing.
- Outer layer sheets can be fixed vertically or horizontally. If fixed vertically, outer layer sheet joints must be offset 600mm from those of the inner layer. Use full height sheets where possible.
- If the wall lining forms part of the structural bracing system, the lining type and fixings must comply with the published bracing system. Check requirements for specific bracing element hold down connections.

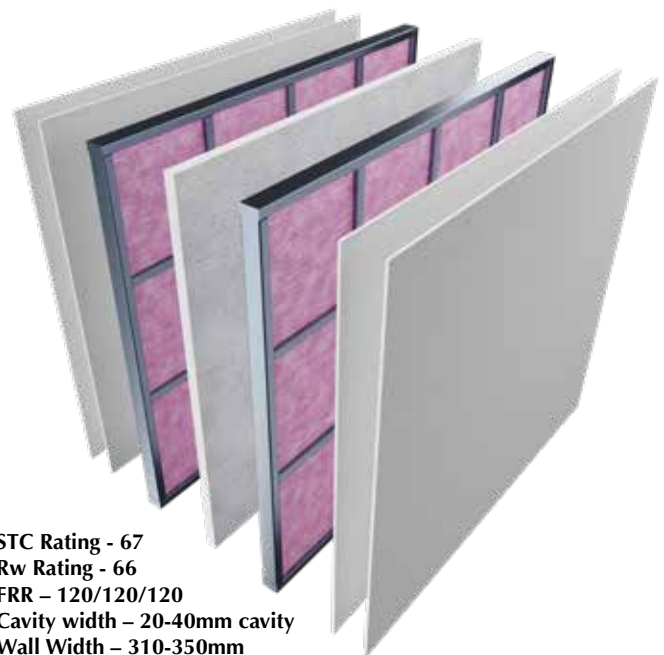

STC Rating - 67
Rw Rating - 66
FRR – 120/120/120
Cavity width – 20-40mm cavity
Wall Width – 310-350mm

Lining Fixings

- 25mm x 6g Self Tapping Drywall Screws
- Outer Layer: 41mm x 6g Self Tapping Drywall Screws
- Place fasteners 12mm from bound sheet edges and 18mm from sheet ends.
- Fix inner sheets vertically. Where sheet end butt joints are unavoidable they must be formed over framing. Use full height sheets where possible.
- Outer layer: If fixing sheets horizontally, fasteners to be placed at 300mm centres to top and bottom plates and perimeter studs. Install pairs of single fasteners to each stud where horizontal joint crosses. Adhesive fix the outer layer to the inner layer with daubs of acoustic adhesive at 300mm centres. Do not place acoustic adhesive at sheet edges or within 200mm of screw fixings.

Acoustic Sealant

- A bead of acoustic sealant is required around the perimeter of the inner wall lining

Jointing

- Jointing and finishing of plasterboard is to be as per the manufacturer's instructions to meet requirements of AS/NZS 2589:2017.

INSA120d - Steel Frame – 120 minute - INTEGRA Lightweight Concrete with 1 layer of 10mm Noise Rated Plasterboard to both framing lines

Framing to comply with

- NZBC B1 – Structure
- NZBC B2 – Durability
- Studs at 600mm centres maximum
- Nogs/Dwangs at 1200mm centres
- Framing dimensions and height as determined by E2/AS4 (NASH Handbook Best Practice for Design and Construction of Residential and Low Rise Steel Framing)

Barrier to comply with

- NZBC Clause B1 Structure
- NZBC Clause B2 Durability
- NZBC Clause C1-C6 – Protection from Fire
- NZBC Clause F2 Hazardous Building Materials
- NZBC Clause G6 Airborne and Impact Sound

Linings

- 1 layer of 10mm Noise Rated Plasterboard on the outside of each framing line.
- Vertical fixing permitted. Sheets shall be touch fitted.
- When fixing vertically, full height sheets shall be used where possible.
- All sheet joints must be formed over solid framing.
- If the wall lining forms part of the structural bracing system, the lining type and fixings must comply with the published bracing system. Check requirements for specific bracing element hold down connections.

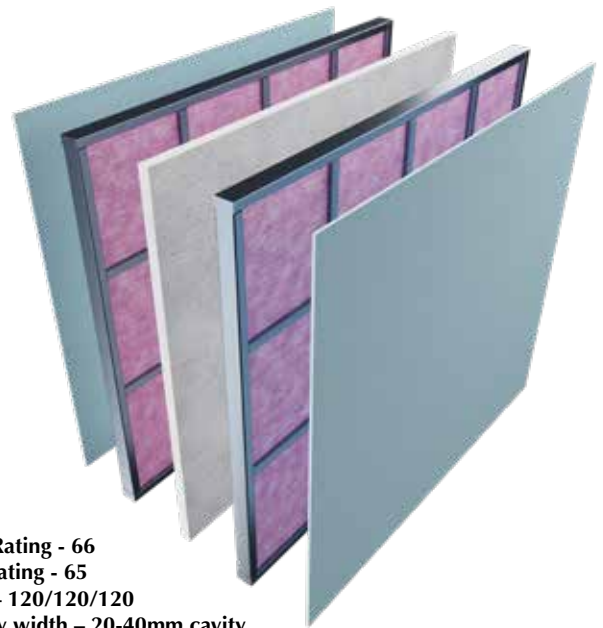

STC Rating - 66
Rw Rating - 65
FRR – 120/120/120
Cavity width – 20-40mm cavity
Wall Width – 290-330mm

Lining Fixings

- 25mm x 6g Self Tapping Drywall Screws
- Lining Fastener Centres 300mm centres to each stud and plate.
- Place fasteners 12mm from bound sheet edges and 18mm from sheet ends.
- If fixing sheets horizontally, fasteners to be placed at 300mm centres to top and bottom plates and perimeter studs. Install pairs of single fasteners to each stud where horizontal joint crosses.

Acoustic Sealant

- A bead of acoustic sealant is required around the perimeter of the wall lining

Jointing

- Jointing and finishing of plasterboard is to be as per the manufacturer's instructions to meet requirements of AS/NZS 2589:2017.

INSA120e - Steel Frame – 120 minute - INTEGRA Lightweight Concrete with 1 layer of 13mm Noise Rated Plasterboard to both framing lines

Framing to comply with

- NZBC B1 – Structure
- NZBC B2 – Durability
- Studs at 600mm centres maximum
- Nogs/Dwangs at 1200mm centres
- Framing dimensions and height as determined by E2/AS4 (NASH Handbook Best Practice for Design and Construction of Residential and Low Rise Steel Framing)

Barrier to comply with

- NZBC Clause B1 Structure
- NZBC Clause B2 Durability
- NZBC Clause C1-C6 – Protection from Fire
- NZBC Clause F2 Hazardous Building Materials
- NZBC Clause G6 Airborne and Impact Sound

Linings

- 1 layer of 13mm Noise Rated Plasterboard on the outside of each framing line.
- Vertical fixing permitted. Sheets shall be touch fitted.
- When fixing vertically, full height sheets shall be used where possible.
- All sheet joints must be formed over solid framing.
- If the wall lining forms part of the structural bracing system, the lining type and fixings must comply with the published bracing system. Check requirements for specific bracing element hold down connections.

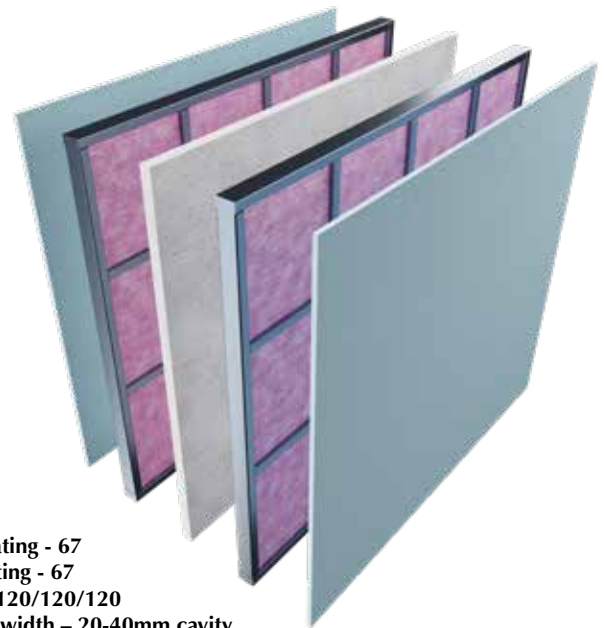

STC Rating - 67
Rw Rating - 67
FRR – 120/120/120
Cavity width – 20-40mm cavity
Wall Width – 296-336mm

Lining Fixings

- 25mm x 6g Self Tapping Drywall Screws
- Lining Fastener Centres 300mm centres to each stud and plate.
- Place fasteners 12mm from bound sheet edges and 18mm from sheet ends.
- If fixing sheets horizontally, fasteners to be placed at 300mm centres to top and bottom plates and perimeter studs. Install pairs of single fasteners to each stud where horizontal joint crosses.

Acoustic Sealant

- A bead of acoustic sealant is required around the perimeter of the wall lining

Jointing

- Jointing and finishing of plasterboard is to be as per the manufacturer's instructions to meet requirements of AS/NZS 2589:2017.

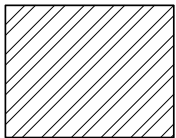
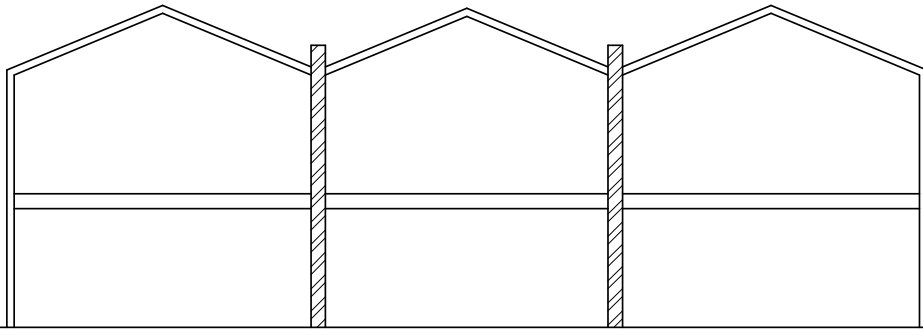
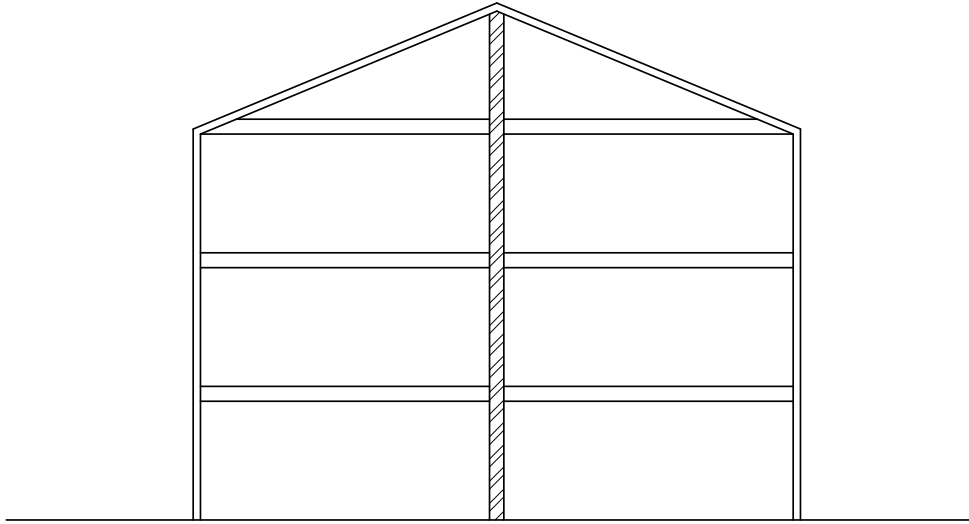

Resene Construction
Systems Intertency
System

TradeSpec™ and RenderSpec™ are Registered Trademarks, both Documents are available on the Resene Construction Systems

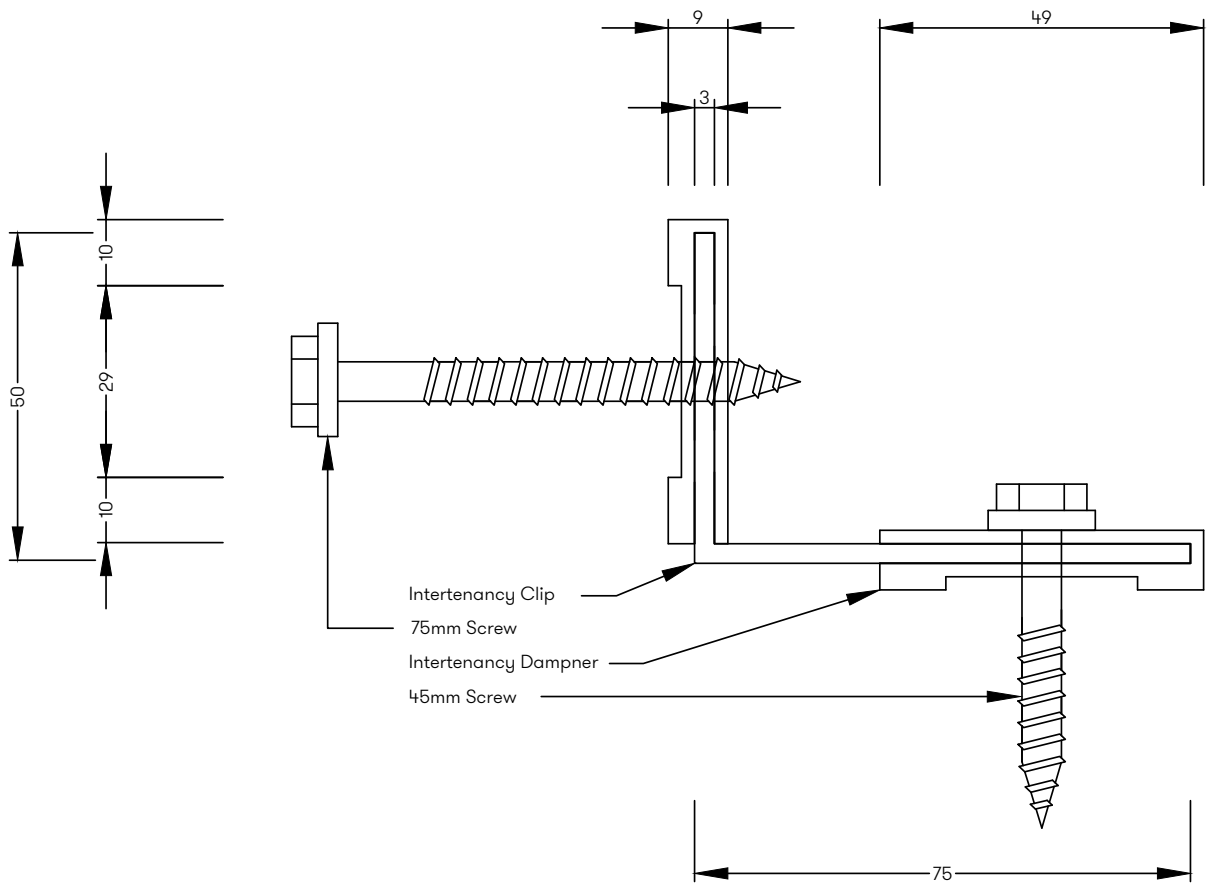
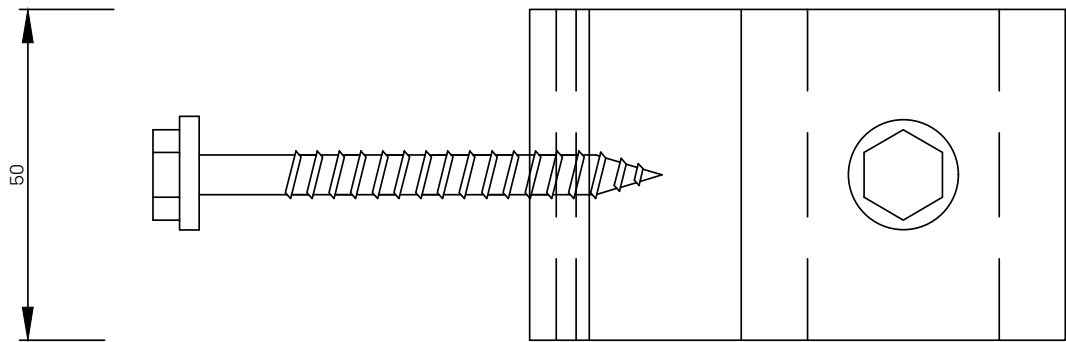

TradeSpec™ and RenderSpec™ are Registered Trademarks, both Documents are available on the Resene Construction Systems



CONFIDENTIALITY: No part of this publication may be reproduced or transmitted other than the intended use by Resene Construction Systems without written consent from the author.

System
INTEGRA Lightweight Concrete Intertenancy System

Scale
1:2 @ A4

Date
1 December 2018

Drawing Name
Intertenancy Bracket

Sheet
34.19.04

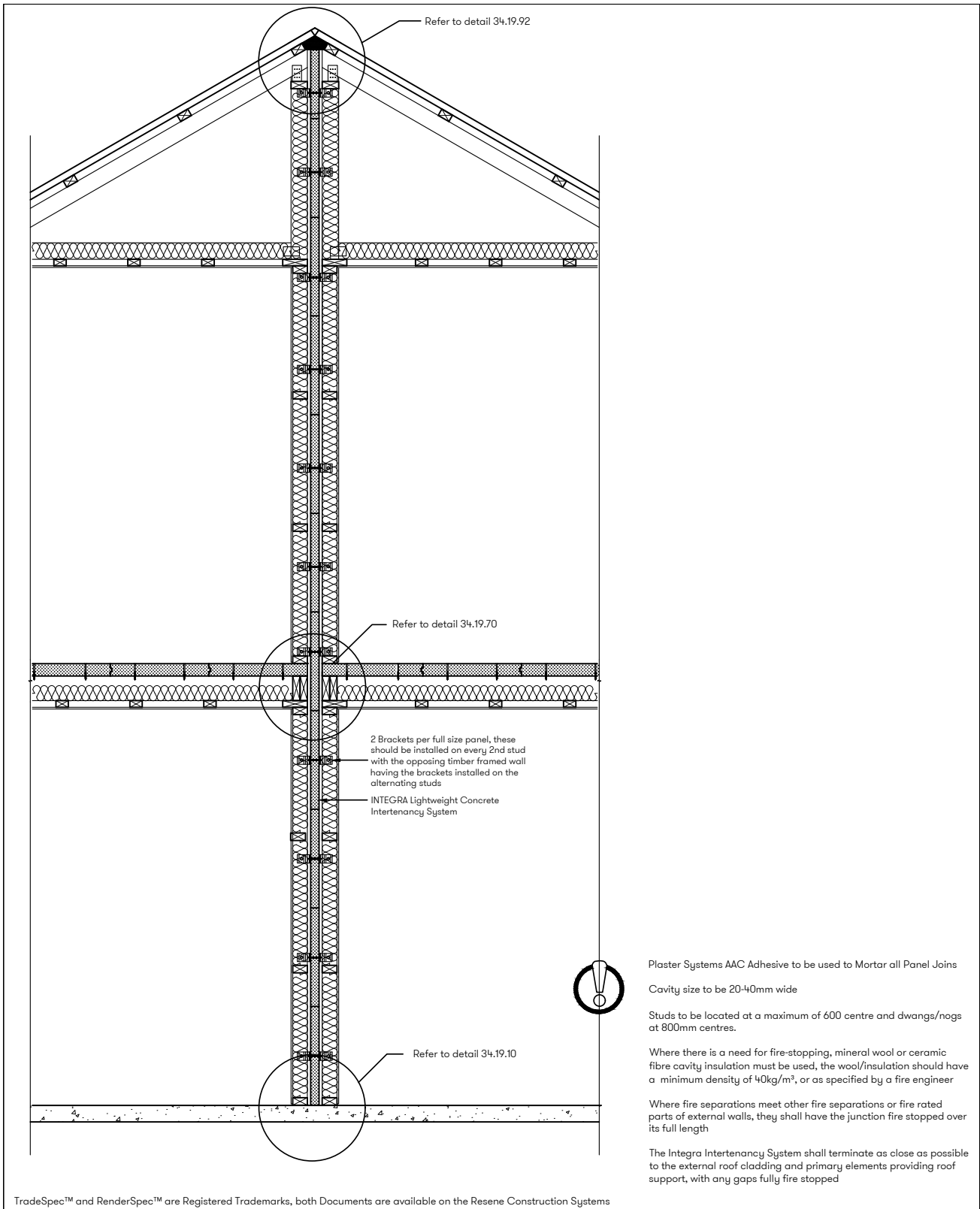

Resene 
Construction Systems

CONFIDENTIALITY: No part of this publication may be reproduced or transmitted other than the intended use by Resene Construction Systems without written consent from the author.

System
 INTEGRA Lightweight Concrete Intertency System

Scale
 1:30 @ A4

Date
 1 December 2018

Drawing Name
 Vertical Cross Section

Sheet
 34.19.05

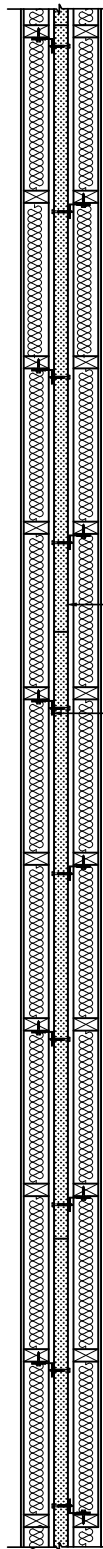

INTEGRA Lightweight Concrete Intertency System

2 Brackets per full size panel, these should be installed on every 2nd stud with the opposing timber framed wall having the brackets installed on the alternating studs



Plaster Systems AAC Adhesive to be used to Mortar all Panel Joins

Cavity size to be 20-40mm wide

Studs to be located at a maximum of 600 centre and dwangs/nogs at 800mm centres.

Where there is a need for fire-stopping, mineral wool or ceramic fibre cavity insulation must be used, the wool/insulation should have a minimum density of 40kg/m³, or as specified by a fire engineer

Where fire separations meet other fire separations or fire rated parts of external walls, they shall have the junction fire stopped over its full length

The Integra Intertency System shall terminate as close as possible to the external roof cladding and primary elements providing roof support, with any gaps fully fire stopped

TradeSpec™ and RenderSpec™ are Registered Trademarks, both Documents are available on the Resene Construction Systems

Resene
Construction Systems

CONFIDENTIALITY: No part of this publication may be reproduced or transmitted other than the intended use by Resene Construction Systems without written consent from the author.

System
INTEGRA Lightweight Concrete Intertency System

Scale
NTS

Date
1 December 2018

Drawing Name
Wall Plan

Sheet
34.19.06

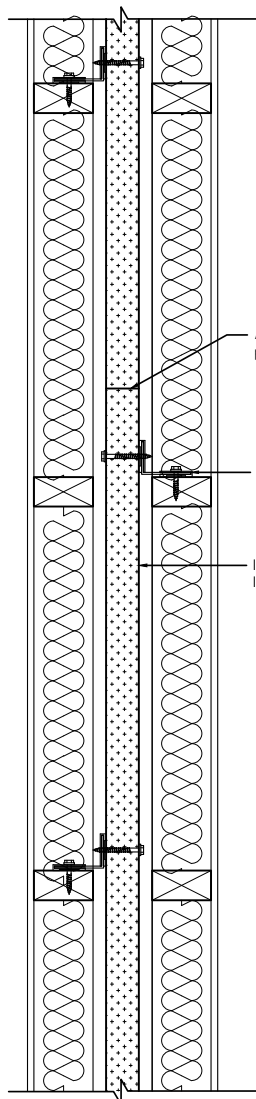

AAC Adhesive to panel joint

2 Brackets per full size panel, these should be installed on every 2nd stud with the opposing timber framed wall having the brackets installed on the alternating studs

INTEGRA Lightweight Concrete Intertency System



Plaster Systems AAC Adhesive to be used to Mortar all Panel Joints

Cavity size to be 20-40mm wide

Studs to be located at a maximum of 600 centre and dwangs/nogs at 800mm centres.

Where there is a need for fire-stopping, mineral wool or ceramic fibre cavity insulation must be used, the wool/insulation should have a minimum density of 40kg/m³, or as specified by a fire engineer

Where fire separations meet other fire separations or fire rated parts of external walls, they shall have the junction fire stopped over its full length

The Integra Intertency System shall terminate as close as possible to the external roof cladding and primary elements providing roof support, with any gaps fully fire stopped

TradeSpec™ and RenderSpec™ are Registered Trademarks, both Documents are available on the Resene Construction Systems



CONFIDENTIALITY: No part of this publication may be reproduced or transmitted other than the intended use by Resene Construction Systems without written consent from the author.

System
INTEGRA Lightweight Concrete Intertency System

Scale
1 : 10 @ A4

Date
1 December 2018

Drawing Name
Wall Plan - Panel Join

Sheet
34.19.07

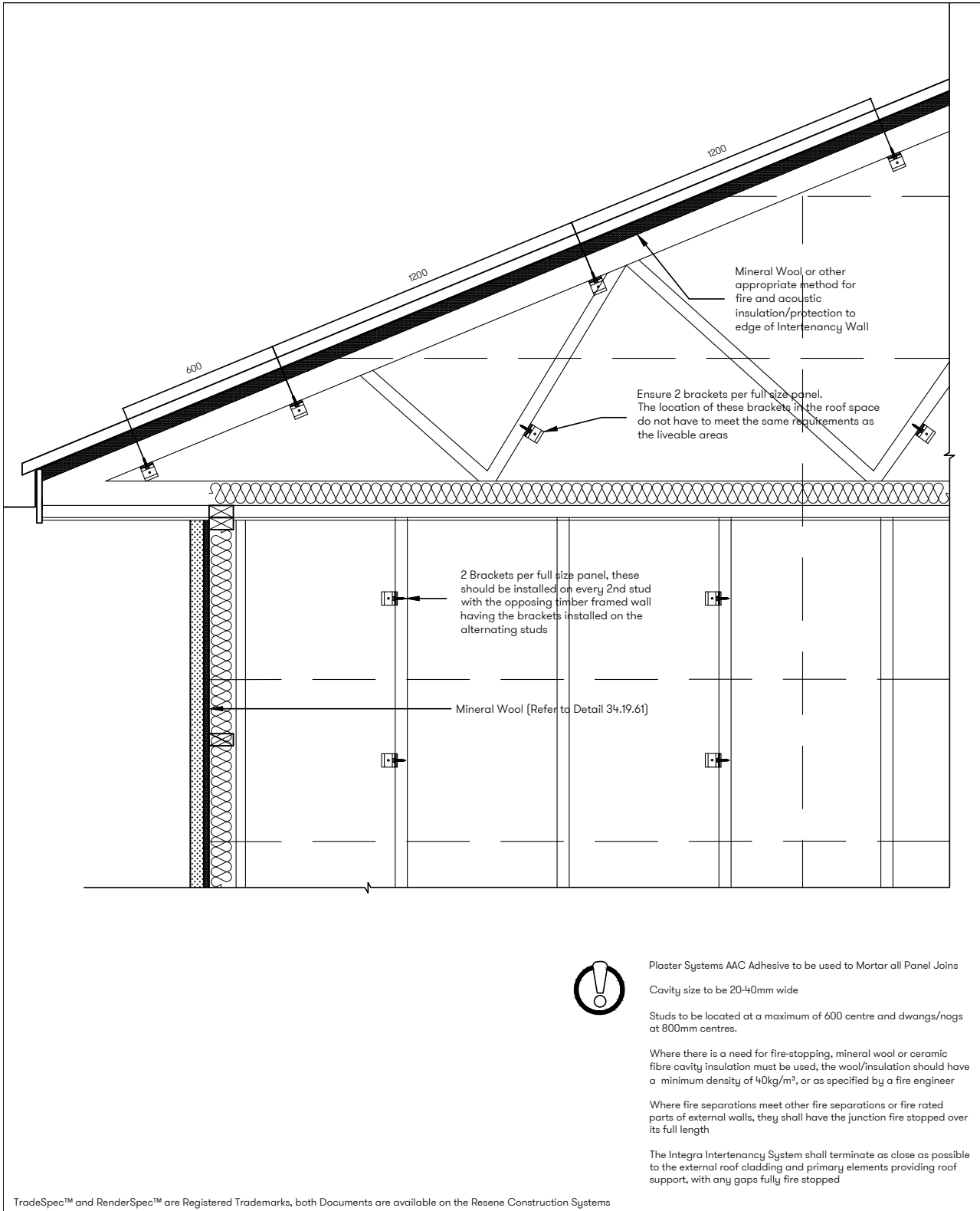

TradeSpec™ and RenderSpec™ are Registered Trademarks, both Documents are available on the Resene Construction Systems



System
 INTEGRA Lightweight Concrete Intertency System

Scale
 1:20 @ A4

Date
 1 December 2018

CONFIDENTIALITY: No part of this publication may be reproduced or transmitted other than the intended use by Resene Construction Systems without written consent from the author.

Drawing Name
 Wall Elevation

Sheet
 34.19.08

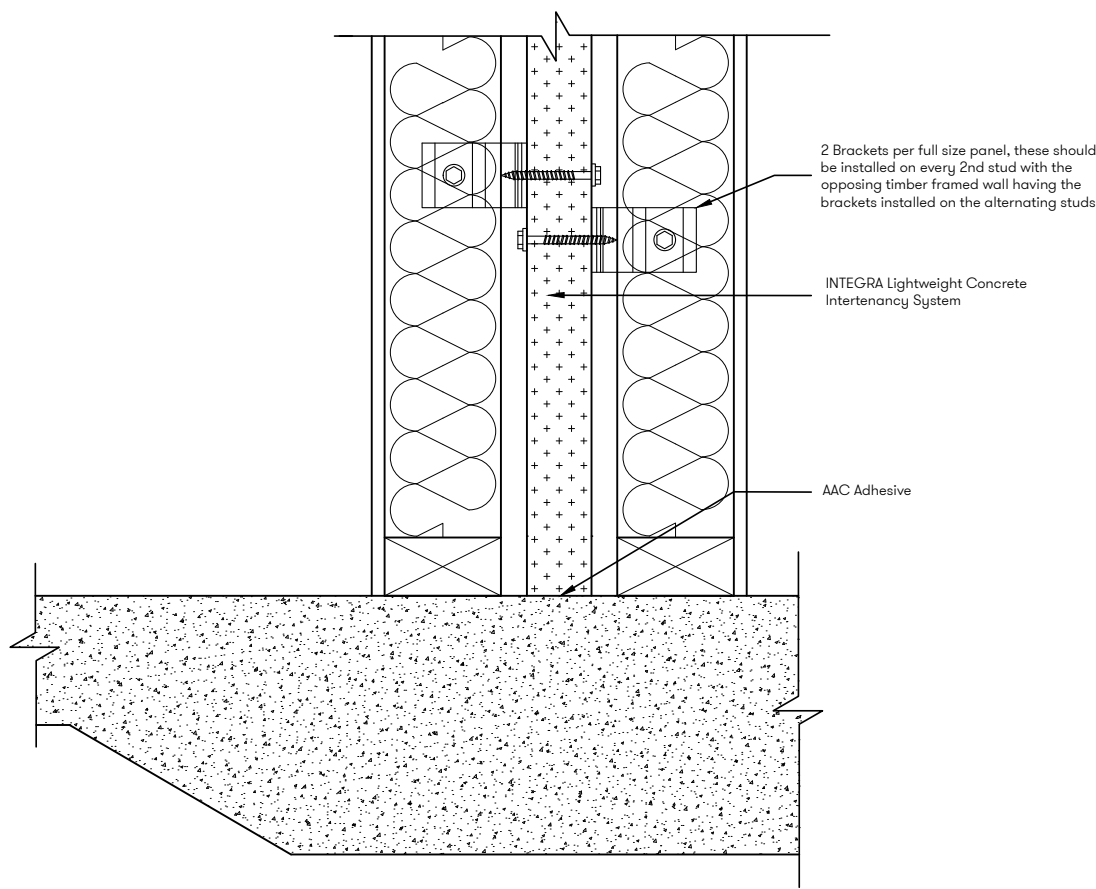

Plaster Systems AAC Adhesive to be used to Mortar all Panel Joins
 Cavity size to be 20-40mm wide
 Studs to be located at a maximum of 600 centre and dwangs/nogs at 800mm centres.
 Where there is a need for fire-stopping, mineral wool or ceramic fibre cavity insulation must be used, the wool/insulation should have a minimum density of 40kg/m³, or as specified by a fire engineer
 Where fire separations meet other fire separations or fire rated parts of external walls, they shall have the junction fire stopped over its full length
 The Integra Intertency System shall terminate as close as possible to the external roof cladding and primary elements providing roof support, with any gaps fully fire stopped

TradeSpec™ and RenderSpec™ are Registered Trademarks, both Documents are available on the Resene Construction Systems



CONFIDENTIALITY: No part of this publication may be reproduced or transmitted other than the intended use by Resene Construction Systems without written consent from the author.

System
 INTEGRA Lightweight Concrete Intertency System

Scale
 1:5 @ A4
 Date
 1 December 2018

Drawing Name
 Foundation or Intermediate Floor Slab

Sheet
 34.19.10

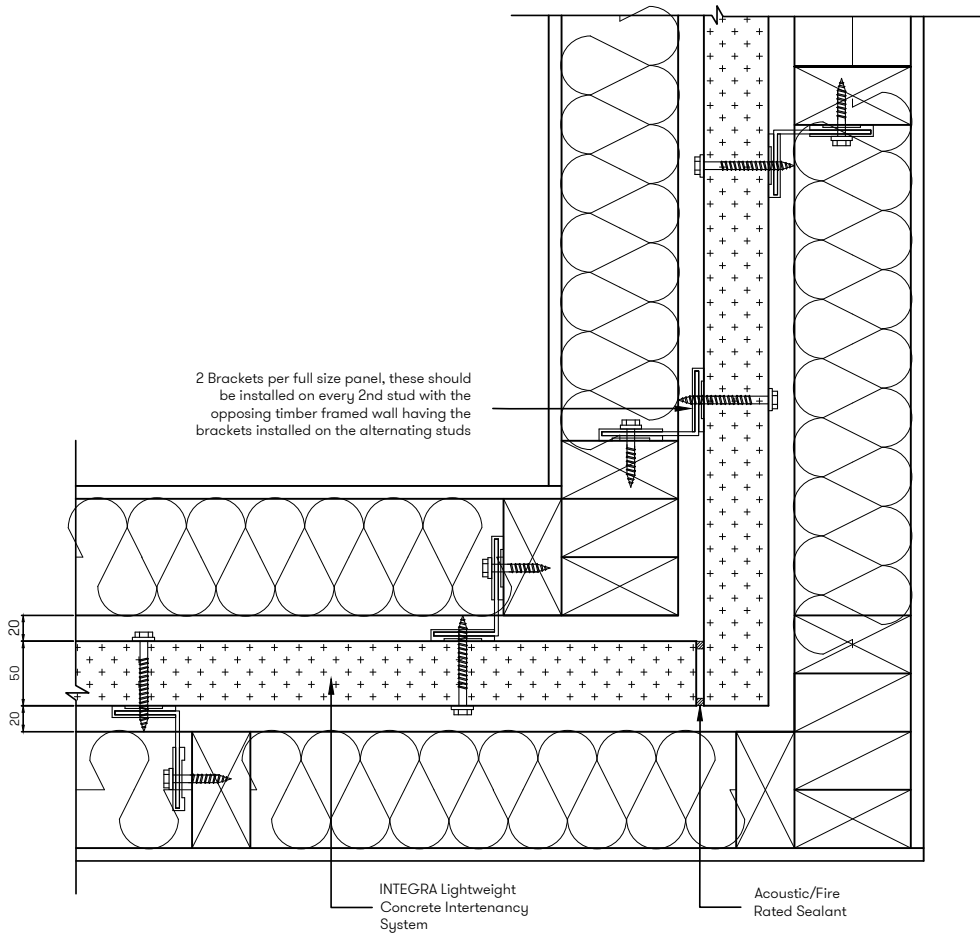

Plaster Systems AAC Adhesive to be used to Mortar all Panel Joins

Cavity size to be 20-40mm wide

Studs to be located at a maximum of 600 centre and dwangs/nogs at 800mm centres.

Where there is a need for fire-stopping, mineral wool or ceramic fibre cavity insulation must be used, the wool/insulation should have a minimum density of 40kg/m³, or as specified by a fire engineer

Where fire separations meet other fire separations or fire rated parts of external walls, they shall have the junction fire stopped over its full length

The Integra Intertency System shall terminate as close as possible to the external roof cladding and primary elements providing roof support, with any gaps fully fire stopped

TradeSpec™ and RenderSpec™ are Registered Trademarks, both Documents are available on the Resene Construction Systems

Resene
Construction Systems

CONFIDENTIALITY: No part of this publication may be reproduced or transmitted other than the intended use by Resene Construction Systems without written consent from the author.

System
INTEGRA Lightweight Concrete Intertency System

Scale
1 : 5 @ A4

Date
1 December 2018

Drawing Name
Corner - Internal Linings both Sides

Sheet
34.19.20

Mineral Wool or Ceramic Fibre Cavity Insulation for fire and acoustic insulation/protection to edge of Intertency Wall

Facade

2 Brackets per full size panel, these should be installed on every 2nd stud with the opposing timber framed wall having the brackets installed on the alternating studs

INTEGRA Lightweight Concrete Intertency System

20 50 20



Plaster Systems AAC Adhesive to be used to Mortar all Panel Joins

Cavity size to be 20-40mm wide

Studs to be located at a maximum of 600 centre and dwangs/nogs at 800mm centres.

Where there is a need for fire-stopping, mineral wool or ceramic fibre cavity insulation must be used, the wool/insulation should have a minimum density of 40kg/m³, or as specified by a fire engineer

Where fire separations meet other fire separations or fire rated parts of external walls, they shall have the junction fire stopped over its full length

The Integra Intertency System shall terminate as close as possible to the external roof cladding and primary elements providing roof support, with any gaps fully fire stopped

TradeSpec™ and RenderSpec™ are Registered Trademarks, both Documents are available on the Resene Construction Systems

Resene
Construction Systems

CONFIDENTIALITY: No part of this publication may be reproduced or transmitted other than the intended use by Resene Construction Systems without written consent from the author.

System
INTEGRA Lightweight Concrete Intertency System

Scale
1 : 5 @ A4

Date
1 December 2018

Drawing Name
Wall Projection - Plan View

Sheet
34.19.43

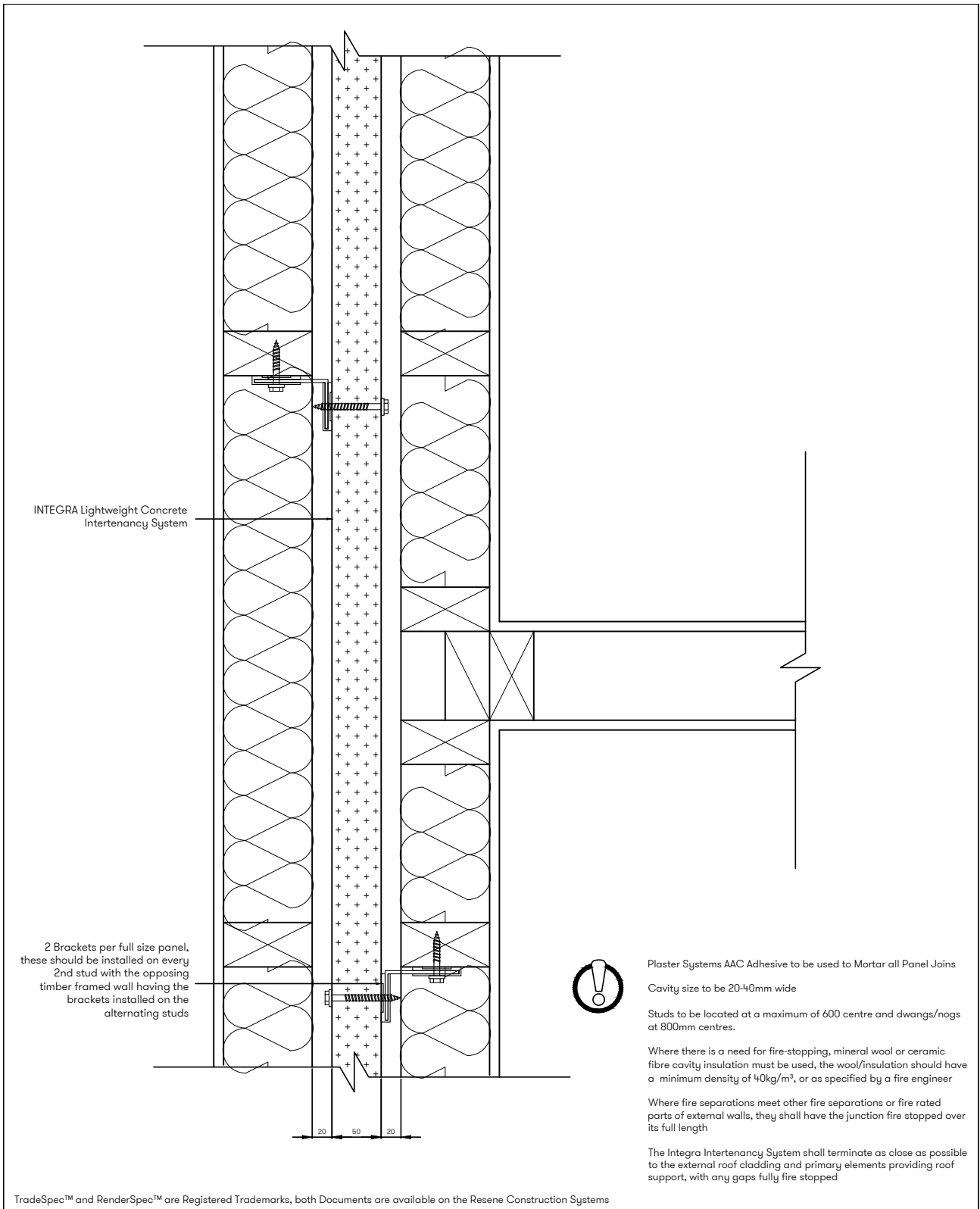

Resene 
Construction Systems

CONFIDENTIALITY: No part of this publication may be reproduced or transmitted other than the intended use by Resene Construction Systems without written consent from the author.

System
 INTEGRA Lightweight Concrete Intertency System

Drawing Name
 T-Junction - Internal Wall meeting Intertency Wall

Scale
 1 : 5 @ A4

Date
 1 December 2018

Sheet
 34.19.60

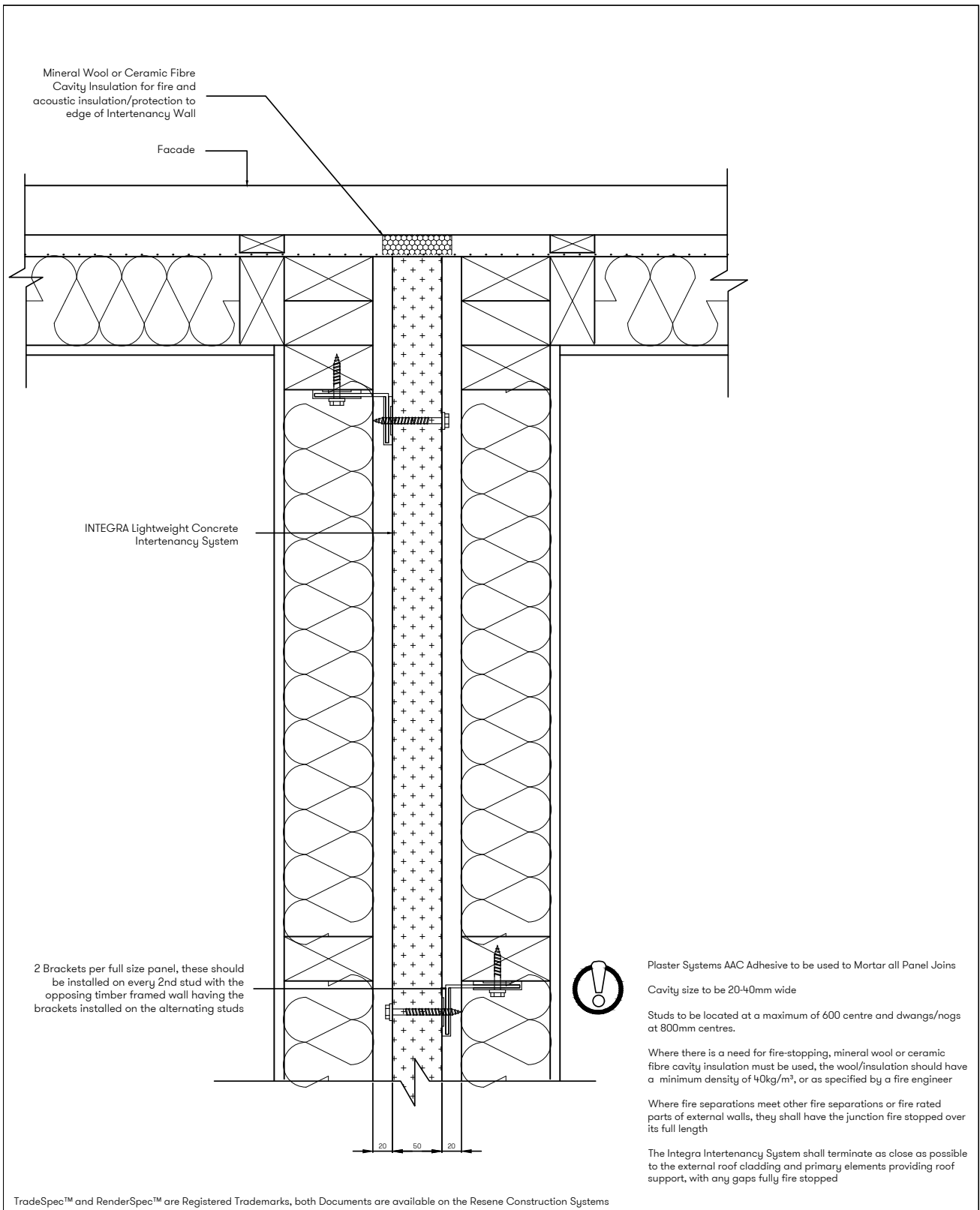

TradeSpec™ and RenderSpec™ are Registered Trademarks, both Documents are available on the Resene Construction Systems

	System	Scale
	INTEGRA Lightweight Concrete Intertency System	1 : 5 @ A4
<small>CONFIDENTIALITY: No part of this publication may be reproduced or transmitted other than the intended use by Resene Construction Systems without written consent from the author.</small>	Date	1 December 2018
	Drawing Name	Sheet
T-Junction - Intertency Wall meeting External Wall	34.19.61	

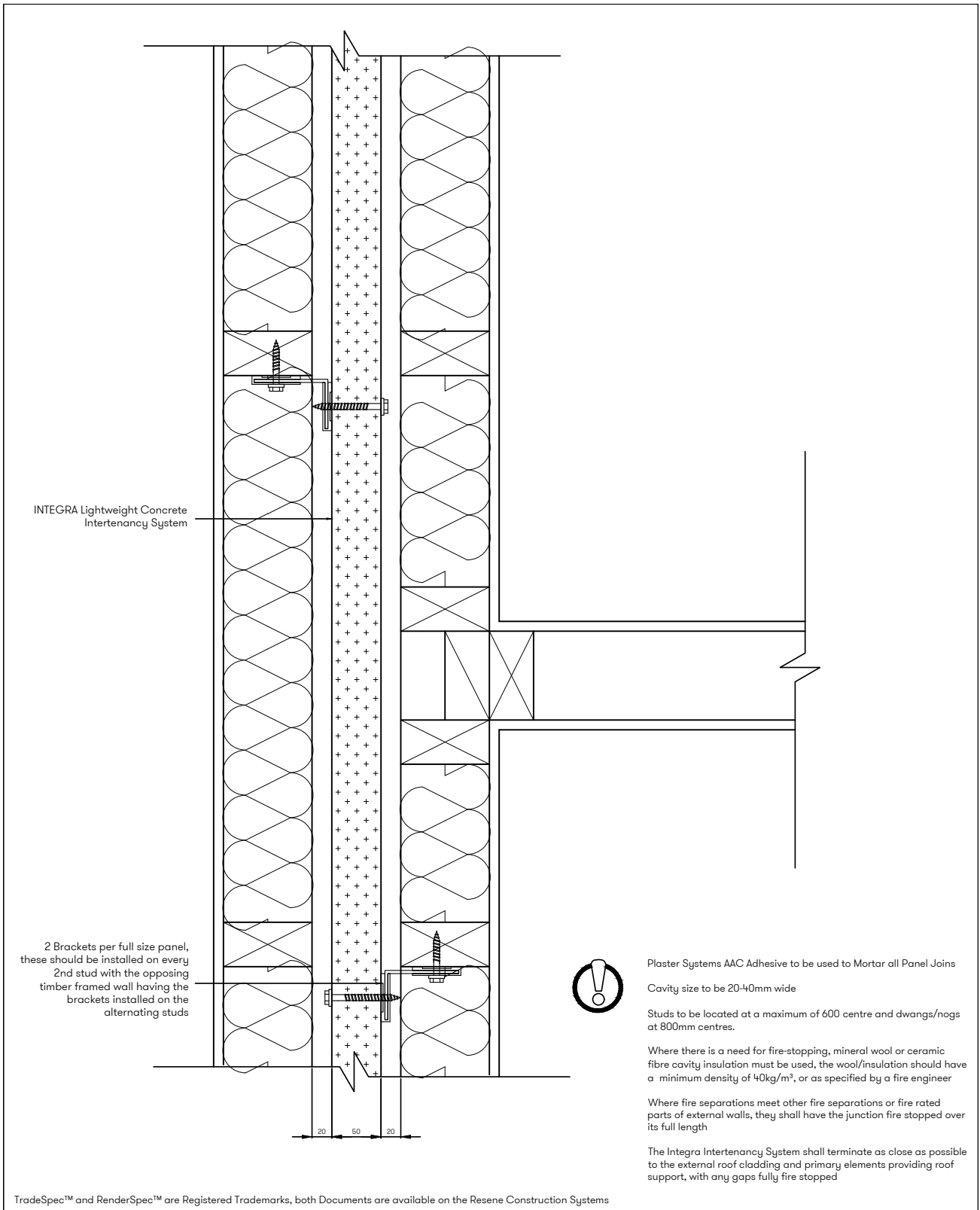

<p>CONFIDENTIALITY: No part of this publication may be reproduced or transmitted other than the intended use by Resene Construction Systems without written consent from the author.</p>	System	Scale
	INTEGRA Lightweight Concrete Intertency System	1 : 5 @ A4
	Drawing Name	Date
	T-Junction - Internal Wall meeting Intertency Wall	1 December 2018
	Sheet	34.19.60

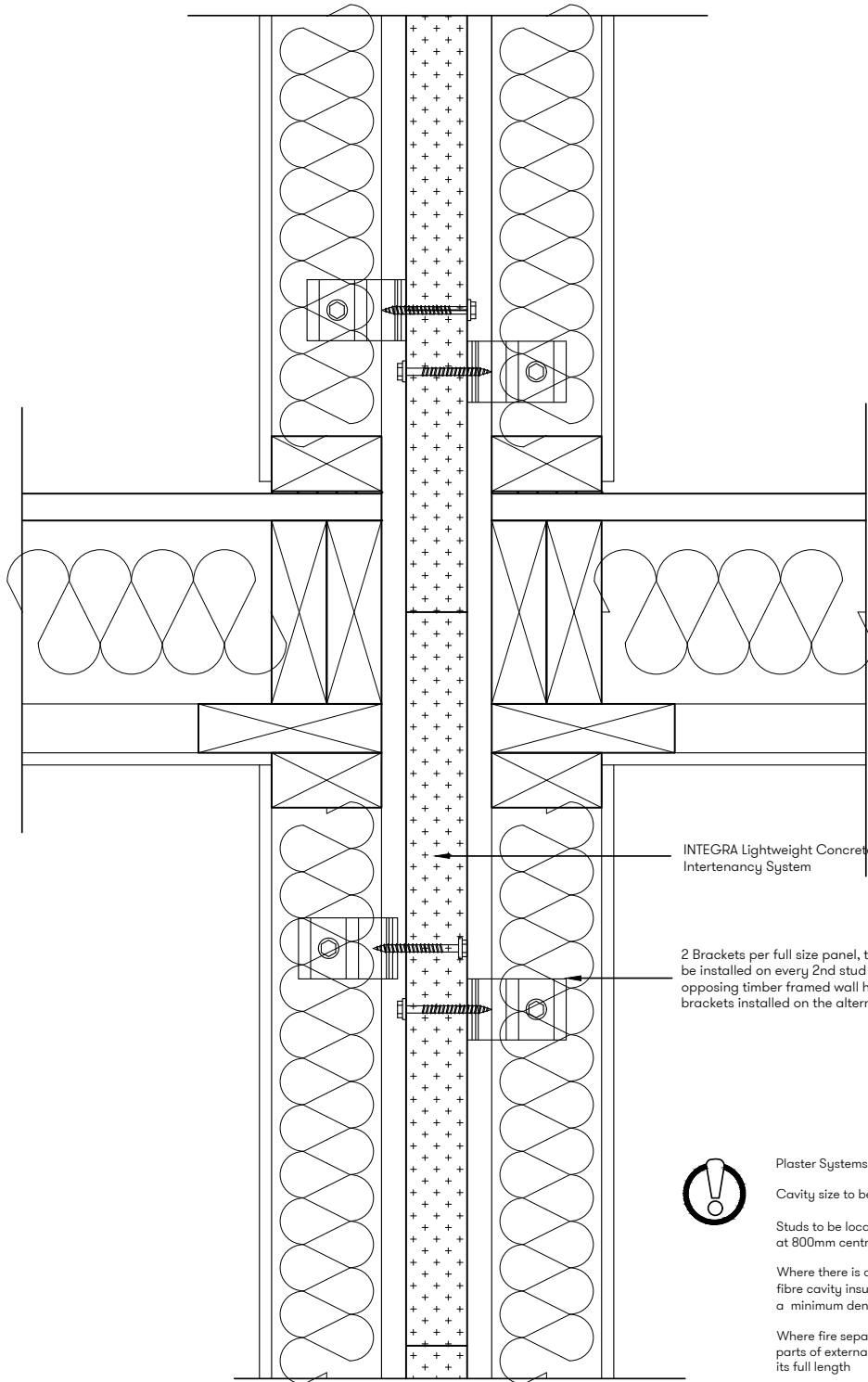

Plaster Systems AAC Adhesive to be used to Mortar all Panel Joins

Cavity size to be 20-40mm wide

Studs to be located at a maximum of 600 centre and dwangs/nogs at 800mm centres.

Where there is a need for fire-stopping, mineral wool or ceramic fibre cavity insulation must be used, the wool/insulation should have a minimum density of 40kg/m³, or as specified by a fire engineer

Where fire separations meet other fire separations or fire rated parts of external walls, they shall have the junction fire stopped over its full length

The Integra Intertency System shall terminate as close as possible to the external roof cladding and primary elements providing roof support, with any gaps fully fire stopped

TradeSpec™ and RenderSpec™ are Registered Trademarks, both Documents are available on the Resene Construction Systems

Resene 
Construction Systems

CONFIDENTIALITY: No part of this publication may be reproduced or transmitted other than the intended use by Resene Construction Systems without written consent from the author.

System
 INTEGRA Lightweight Concrete Intertency System

Scale
 1 : 5 @ A4

Date
 1 December 2018

Drawing Name
 Mid-floor

Sheet
 34.19.70

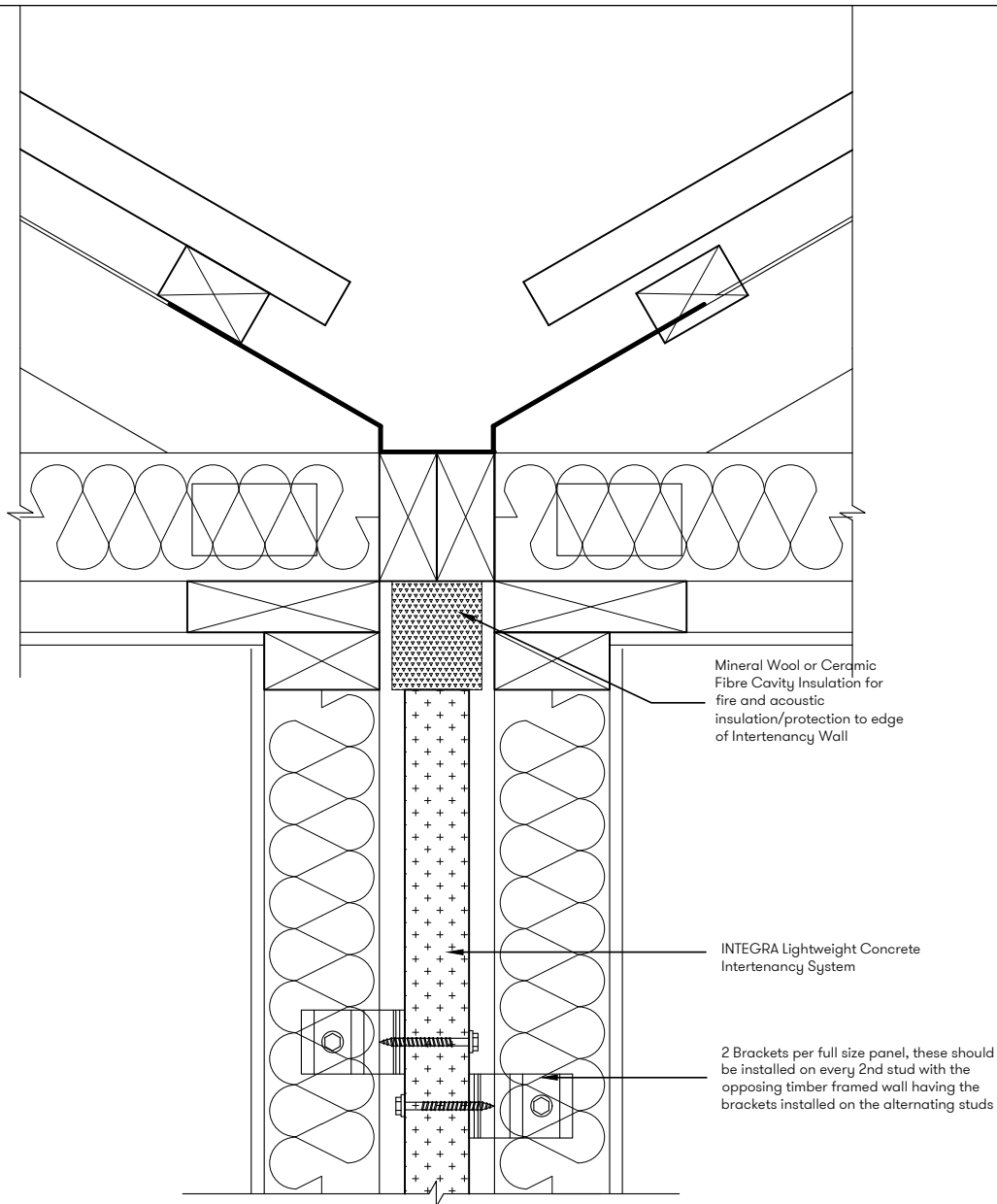

Mineral Wool or Ceramic Fibre Cavity Insulation for fire and acoustic insulation/protection to edge of Intertency Wall

INTEGRA Lightweight Concrete Intertency System

2 Brackets per full size panel, these should be installed on every 2nd stud with the opposing timber framed wall having the brackets installed on the alternating studs



Plaster Systems AAC Adhesive to be used to Mortar all Panel Joins

Cavity size to be 20-40mm wide

Studs to be located at a maximum of 600 centre and dwangs/nogs at 800mm centres.

Where there is a need for fire-stopping, mineral wool or ceramic fibre cavity insulation must be used, the wool/insulation should have a minimum density of 40kg/m³, or as specified by a fire engineer

Where fire separations meet other fire separations or fire rated parts of external walls, they shall have the junction fire stopped over its full length

The Integra Intertency System shall terminate as close as possible to the external roof cladding and primary elements providing roof support, with any gaps fully fire stopped

TradeSpec™ and RenderSpec™ are Registered Trademarks, both Documents are available on the Resene Construction Systems



CONFIDENTIALITY: No part of this publication may be reproduced or transmitted other than the intended use by Resene Construction Systems without written consent from the author.

System
INTEGRA Lightweight Concrete Intertency System

Scale
1 : 5 @ A4

Date
1 December 2018

Drawing Name
Roof Valley

Sheet
34.19.91

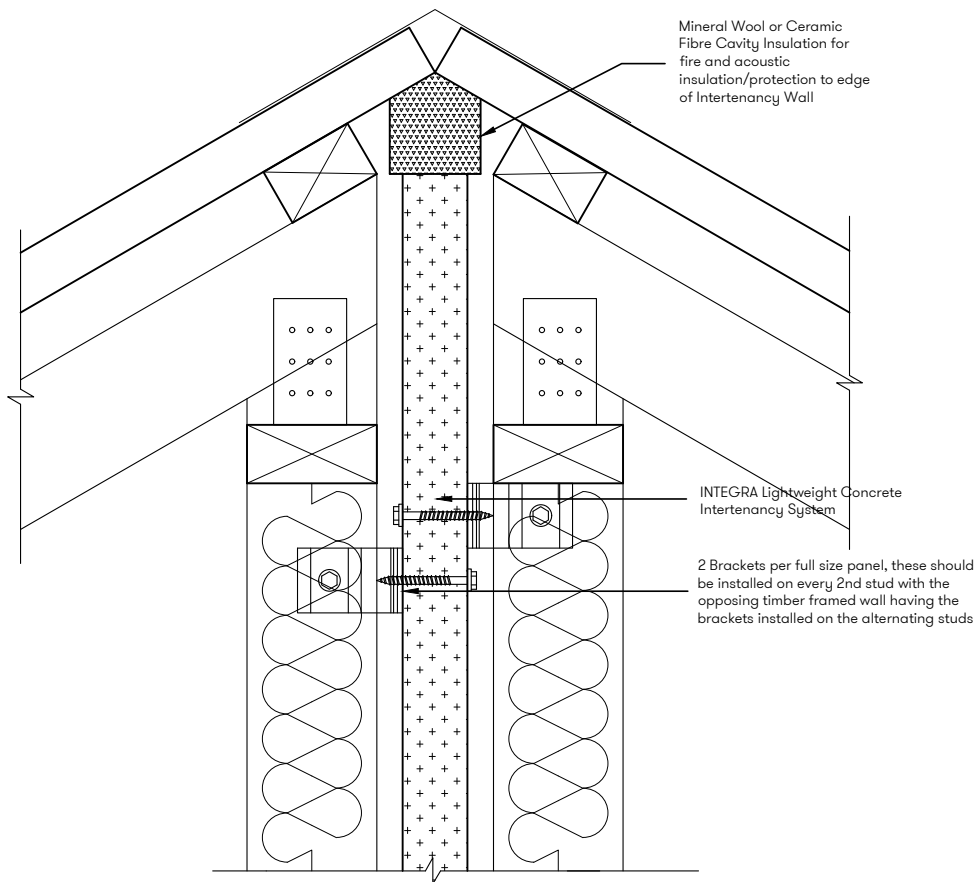

Plaster Systems AAC Adhesive to be used to Mortar all Panel Joins

Cavity size to be 20-40mm wide

Studs to be located at a maximum of 600 centre and dwangs/nogs at 800mm centres.

Where there is a need for fire-stopping, mineral wool or ceramic fibre cavity insulation must be used, the wool/insulation should have a minimum density of 40kg/m³, or as specified by a fire engineer

Where fire separations meet other fire separations or fire rated parts of external walls, they shall have the junction fire stopped over its full length

The Integra Intertency System shall terminate as close as possible to the external roof cladding and primary elements providing roof support, with any gaps fully fire stopped

TradeSpec™ and RenderSpec™ are Registered Trademarks, both Documents are available on the Resene Construction Systems



CONFIDENTIALITY: No part of this publication may be reproduced or transmitted other than the intended use by Resene Construction Systems without written consent from the author.

System
INTEGRA Lightweight Concrete Intertency System

Scale
1: 5 @ A4

Date
1 December 2018

Drawing Name
Roof Ridge

Sheet
34.19.92

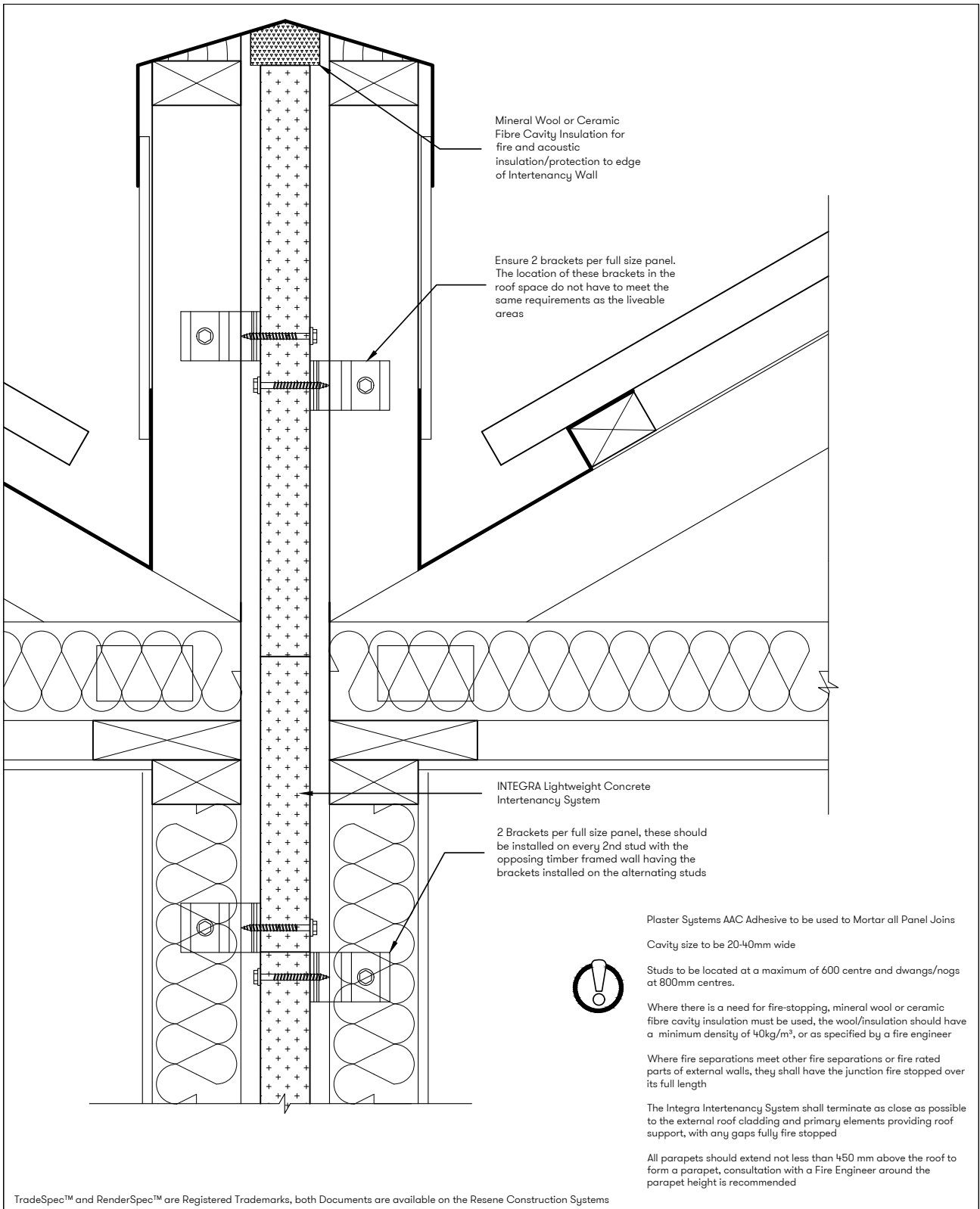

Resene 
Construction Systems

CONFIDENTIALITY: No part of this publication may be reproduced or transmitted other than the intended use by Resene Construction Systems without written consent from the author.

System
 INTEGRA Lightweight Concrete Intertency System

Scale
 1: 5 @ A4

Date
 1 December 2018

Drawing Name
 Roof Parapet

Sheet
 34.19.93

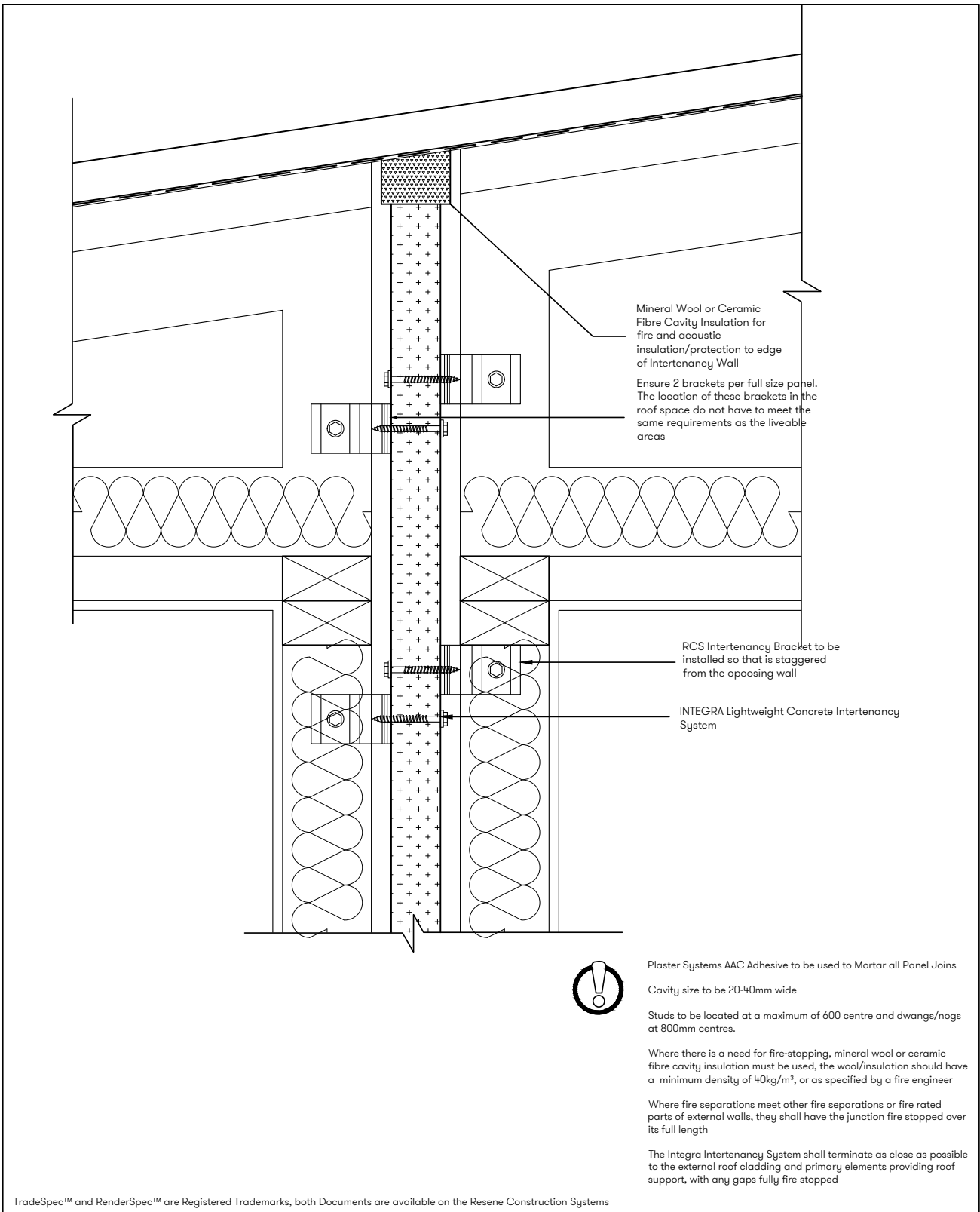

CONFIDENTIALITY: No part of this publication may be reproduced or transmitted other than the intended use by Resene Construction Systems without written consent from the author.

System
INTEGRA Lightweight Concrete Intertency System

Scale
1:5 @ A4

Date
1 December 2018

Drawing Name
Sloping Roof End

Sheet
34.19.94

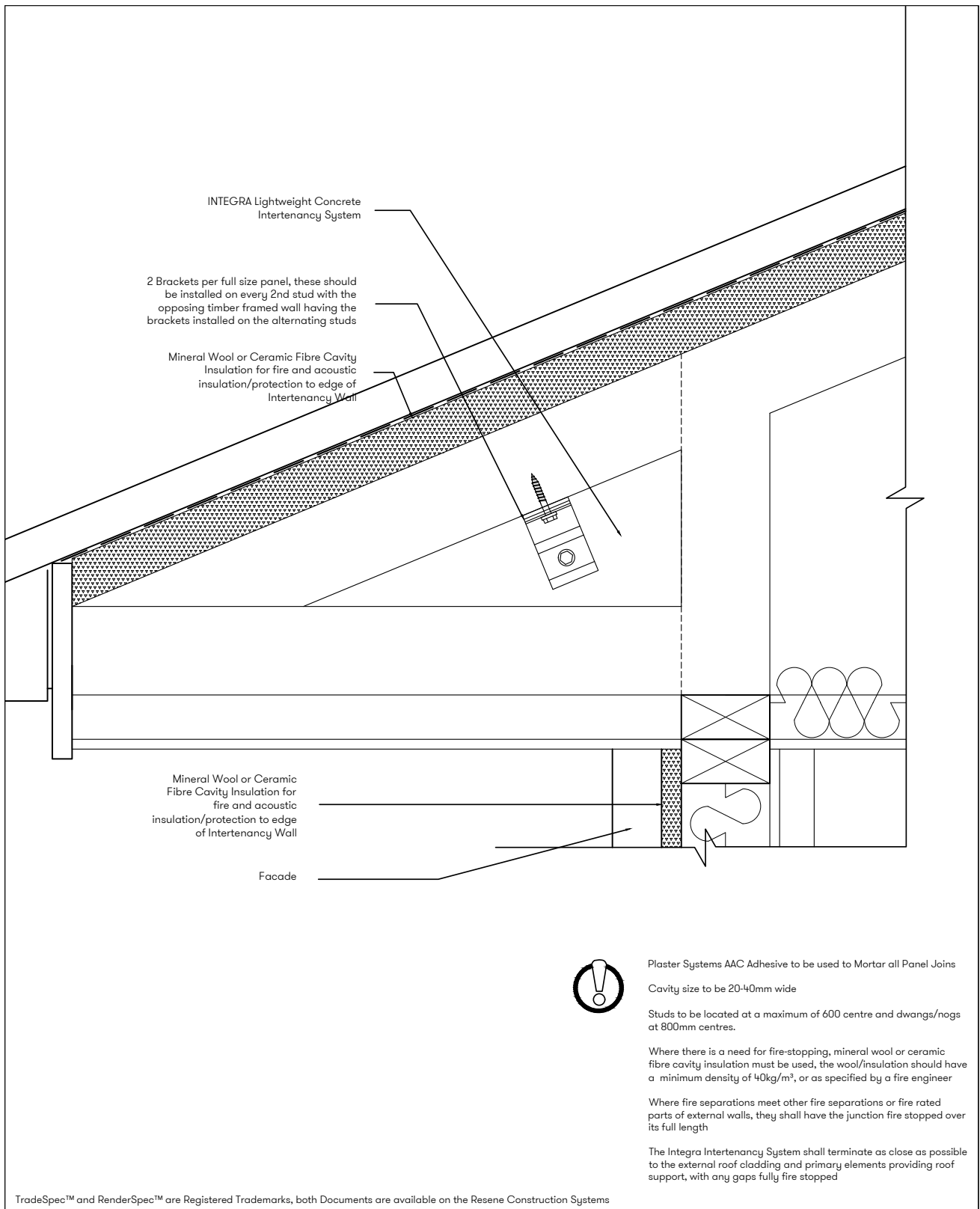

Resene 
Construction Systems

CONFIDENTIALITY: No part of this publication may be reproduced or transmitted other than the intended use by Resene Construction Systems without written consent from the author.

System
 INTEGRA Lightweight Concrete Intertency System

Drawing Name
 Eave

Scale
 1 : 5 @ A4

Date
 1 December 2018

Sheet
 34.19.96

Our Products

ROCKCOTE[®]

Premium plaster facade systems, pre-coloured, flexible acrylic and mineral coatings for interior and exterior use.

ARTISAN

NATURAL MATERIALS
BY ROCKCOTE

Bespoke range of natural plasters that enhance and define interior and exterior environments.

Seismolock

Reinforced plaster strengthening system offering an economical alternative to traditional post construction earthquake strengthening methods.

Ezyplast

INTERIOR HARDWALLED PLASTER

Gypsum-based interior hardwall plaster hand applied over concrete blocks, masonry, bricks, metal lathe or plaster board.

Villastop

Fine, sandable finishing plaster for use over cement sheet and other masonry substrates.

Plaster **Systems**[™]

Mineral plasters, and textures for exterior and interior use.

NTEGRA

LIGHTWEIGHT CONCRETE SYSTEMS

Premium lightweight AAC concrete facade, flooring, intertenancy and fencing systems. Providing impact, fire and acoustic resistance with the durability of lightweight concrete.

graphex.

A graphite infused insulation panel specially designed to significantly improve external insulation of your project.

MULTI **STOP**

PATCH, REPAIR & FINISH

A range of patching, repairing and finishing plasters for masonry substrates.

Multiplast

Fibre cement sheet jointing system, and repair plaster.

Branches at : Auckland, Tauranga, Napier, Wellington, Christchurch.

[www. reseneconstruction.co.nz](http://www.reseneconstruction.co.nz) | 0800 50 70 40